

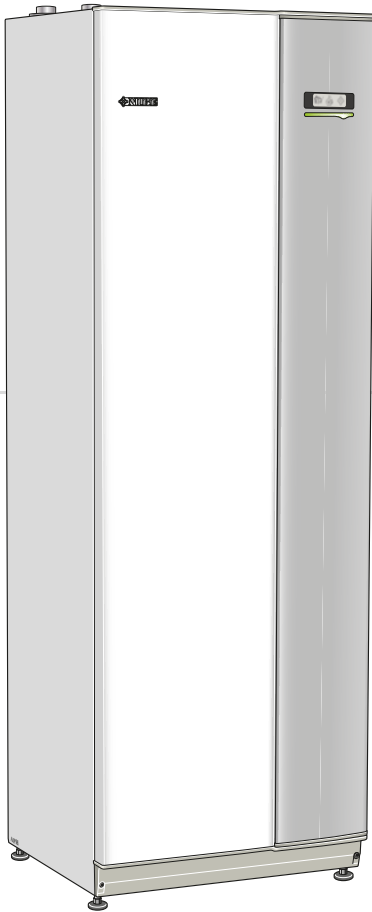

User manual
NIBE™ VVM 310
Indoor module



UHB GB 1338-3
231176

Quick guide

Navigation

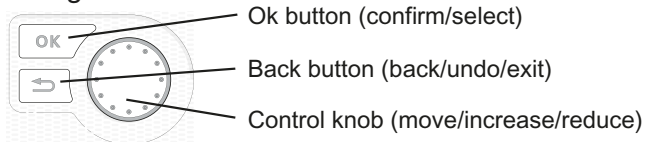

A detailed explanation of the button functions can be found on page 12.

How to scroll through menus and make different settings is described on page 16.

Set the indoor climate

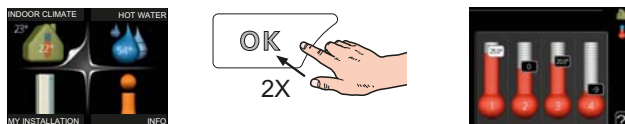

The mode for setting the indoor temperature is reached, when in the start mode in the main menu, by pressing the OK button twice. Read more about the settings on page 25.

Increase hot water volume

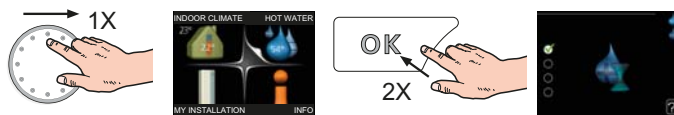

To temporarily increase the amount of hot water, first turn the control knob to mark menu 2 (water droplet) and then press the OK button twice. Read more about the settings on page 36.

In event of disturbances in comfort

If a disturbance in comfort of any type occurs there are some measures that can be taken before you need to contact your installer. See page 58 for instructions.

Table of Contents

1	<i>Important information</i>	2
	Important information	2
2	<i>The heating installation – the heart of the house</i>	9
	Installation function	10
	Contact with VVM 310	11
	Maintenance of VVM 310	21
3	<i>VVM 310 – at your service</i>	25
	Set the indoor climate	25
	Set the hot water capacity	36
	Get information	40
	Adjust the indoor module	43
4	<i>Disturbances in comfort</i>	56
	Info-menu	56
	Manage alarm	56
	Troubleshooting	58
5	<i>Technical data</i>	60
6	<i>Glossary</i>	61
	<i>Item register</i>	65

1 Important information

Important information

Installation data

Product	VVM 310
Serial number	
Installation date	
Installer	

No.	Name	De- fault set- tings	Set		✓	Accessories
1.1	temperature (heating curve offset)	0				
1.9.1	heating curve (curve slope)	9				
1.9.3	min. flow line temp.	20				

Serial number must always be given

Certification that the installation is carried out according to instructions in NIBE's installer manual and applicable regulations.

Date _____ Signed _____

Safety information

This appliance can be used by children aged from 8 years and above and persons with reduced physical, sensory or mental capabilities or lack of experience and knowledge if they have been given supervision or instruction concerning use of the appliance in a safe way and understand the hazards involved. Children shall not play with the appliance. Cleaning and user maintenance shall not be made by children without supervision.

Rights to make any design or technical modifications are reserved.

©NIBE 2013.



NOTE

VVM 310 must be installed via an isolator switch with a minimum breaking gap of 3 mm.



NOTE

If the supply cable is damaged, only NIBE, its service representative or similar authorised person may replace it to prevent any danger and damage.

System pressure	Max	Min
Heating medium	0.3 MPa (3 bar)	0.01 MPa (0.1 bar)
Domestic water	1.0 MPa (10 bar)	0.01 MPa (0.1 bar)

Symbols



NOTE

This symbol indicates danger to machine or person.



Caution

This symbol indicates important information about what you should observe when maintaining your installation.

**TIP**

This symbol indicates tips on how to facilitate using the product.

Marking

VVM 310 is CE marked and fulfils IP21.

The CE marking means that NIBE ensures that the product meets all regulations that are placed on it based on relevant EU directives. The CE mark is obligatory for most products sold in the EU, regardless where they are made.

IP21 means that the product can be touched by hand, that objects with a diameter larger than or equivalent to 12.5 mm cannot penetrate and cause damage and that the product is protected against vertically falling drops.

Serial number

The serial number can be found at the bottom right of the front cover and in the info menu (menu 3.1).

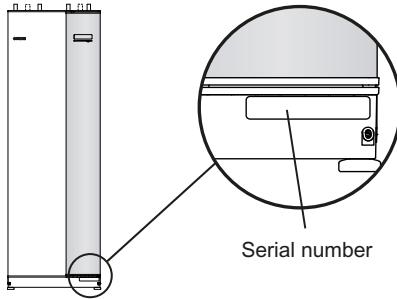

Caution

Always give the product's serial number (14 digits) when reporting a fault.

Contact information

AT KNV Energietechnik GmbH, Gahberggasse 11, 4861 Schörföling

Tel: +43 (0)7662 8963-0 Fax: +43 (0)7662 8963-44 E-mail: mail@knv.at
www.knv.at

CH NIBE Wärmetechnik AG, Winterthurerstrasse 710, CH-8247 Flurlingen

Tel: (52) 647 00 30 Fax: (52) 647 00 31 E-mail: info@nibe.ch www.nibe.ch

CZ Druzstevni zavody Drazice s.r.o., Drazice 69, CZ - 294 71 Benátky nad Jizerou

Tel: +420 326 373 801 Fax: +420 326 373 803 E-mail: nibe@nibe.cz
www.nibe.cz

DE NIBE Systemtechnik GmbH, Am Reiherpfahl 3, 29223 Celle

Tel: 05141/7546-0 Fax: 05141/7546-99 E-mail: info@nibe.de
www.nibe.de

DK Vølund Varmeteknik A/S, Member of the Nibe Group, Brogårdsvej 7, 6920 Videbæk

Tel: 97 17 20 33 Fax: 97 17 29 33 E-mail: info@volundvt.dk www.volundvt.dk

FI NIBE Energy Systems OY, Juurakkotie 3, 01510 Vantaa

Puh: 09-274 697 0 Fax: 09-274 697 40 E-mail: info@nibe.fi www.nibe.fi

FR AIT France, 10 rue des Moines, 67000 Haguenau

Tel : 03 88 06 24 10 Fax : 03 88 06 90 15 E-mail: info@nibe.fr www.nibe.fr

GB NIBE Energy Systems Ltd, 3C Broom Business Park, Bridge Way, Chesterfield S41 9QG

Tel: 0845 095 1200 Fax: 0845 095 1201 E-mail: info@nibe.co.uk
www.nibe.co.uk

NL NIBE Energietechniek B.V., Postbus 2, NL-4797 ZG WILLEMSTAD (NB)

Tel: 0168 477722 Fax: 0168 476998 E-mail: info@nibenl.nl www.nibenl.nl

NO ABK AS, Brobekkveien 80, 0582 Oslo, Postadresse: Postboks 64 Vollebakk, 0516 Oslo

Tel. sentralbord: +47 23 17 05 20 E-mail: post@abkklima.no www.nibeen-ergysystems.no

PL NIBE-BIAWAR Sp. z o. o. Aleja Jana Pawła II 57, 15-703 BIAŁYSTOK

Tel: 085 662 84 90 Fax: 085 662 84 14 E-mail: sekretariat@biawar.com.pl
www.biawar.com.pl

RU © "EVAN" 17, per. Boynovskiy, Nizhny Novgorod

Tel./fax +7 831 419 57 06 E-mail: info@evan.ru www.nibe-ivan.ru

SE NIBE AB Sweden, Box 14, Hannabadsvägen 5, SE-285 21 Markaryd

Tel: +46-(0)433-73 000 Fax: +46-(0)433-73 190 E-mail: info@nibe.se
www.nibe.se

For countries not mention in this list, please contact Nibe Sweden or check www.nibe.eu for more information.

VVM 310 - An excellent choice

VVM 310 is part of a new generation of products, which have been introduced to supply your home with inexpensive and environmentally friendly heating. Heat production is safe and economical with integrated hot water coil, immersion heater, circulation pumps and control system.

The indoor module can be connected to an optional low temperature heat distribution system, e.g. radiators, convectors or underfloor heating. It is also prepared for connection to a number of different products and accessories, e.g. solar or other external heat source, extra water heater, swimming pool and climate systems with different temperatures.

VVM 310 is equipped with a control computer for good comfort, good economy and safe operation. Clear information about status, operating time and all temperatures in the system is shown on the large and easy to read display. This means, for example, that external unit thermometers are not necessary.

Excellent properties for VVM 310:

■ ***Coil for hot water***

There is a stainless steel hot water coil integrated in the indoor module. The water in the coil is heated by the hot water in the surrounding tank.

■ ***Buffer vessel***

There is a buffer vessel integrated in the indoor module that equalises the temperature of the water that is sent out in the climate system.

■ ***Scheduling the indoor comfort and hot water***

Heating and hot water can be scheduled for each day of the week or for longer periods (vacation).

■ ***Large display with user instructions***

The indoor module has a large display with easy-to-understand menus that facilitate setting a comfortable climate.

■ ***Simple troubleshooting***

In the event of a fault, the indoor module display shows what happened and the actions to be taken.

■ ***Easy to install***

The indoor module is easy to install together with NIBE F20XX or another air water heat pump. When installing together with F20XX the heat pump's values can be read off from the indoor module's display.

■ ***External heat source***

VVM 310 is prepared for easy connection to a solar panel installation and/or oil/gas/ wood fired boiler and district heating.

2 The heating installation – the heart of the house

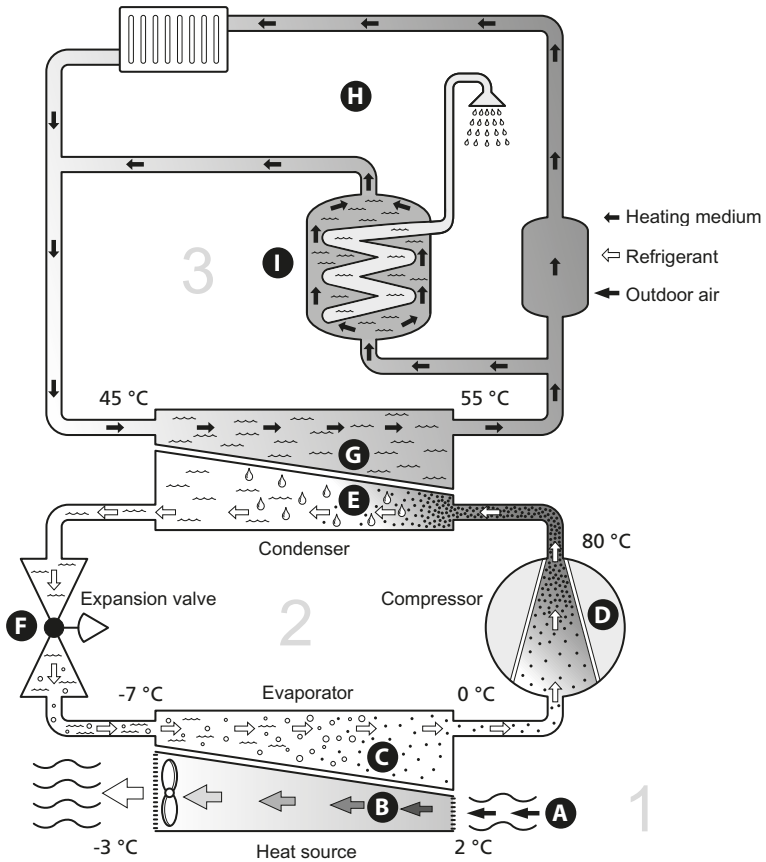

The temperatures are only examples and may vary between different installations and time of year.

Installation function

An air/water-heat pump installation exploits outdoor air to heat up accommodation. The conversion of the outdoor air's energy to accommodation heating occurs in three different circuits. *From the outdoor air, (1) , free heat energy is retrieved and transported to the heat pump. In the refrigerant circuit, (2) the heat pump increases the retrieved heat's low temperature to a high temperature. In the heating medium circuit, (3) the heat is distributed around the house.

Outdoor air

- A The outdoor air is sucked into the heat pump.
- B The fan then routes the air to the heat pump's evaporator. Here, the air releases the heating energy to the refrigerant and the air's temperature drops. The cold air is then blown out of the heat pump.

Refrigerant circuit

- C A gas circulates in a closed system in the heat pump, a refrigerant, which also passes the evaporator. The refrigerant has a very low boiling point. In the evaporator the refrigerant receives the heat energy from the outdoor air and starts to boil.
- D The gas that is produced during boiling is routed into an electrically powered compressor. When the gas is compressed, the pressure increases and the gas's temperature increases considerably, from 0 °C to approx 80 °C.
- E From the compressor, gas is forced into a heat exchanger, condenser, where it releases heat energy to the indoor module, whereupon the gas is cooled and condenses to a liquid form again.
- F As the pressure is still high, the refrigerant can pass an expansion valve, where the pressure drops so that the refrigerant returns to its original temperature. The refrigerant has now completed a full cycle. It is routed to the evaporator again and the process is repeated.

Heat medium circuit

- G The heat energy that the refrigerant produces in the condenser is retrieved by the indoor module's water, the heating medium, which is heated to 55 °C (supply temperature).
- H The heating medium circulates in a closed system and transports the heated water's heat energy to the house radiators/heating coils.
- I The indoor module's integrated hot water heater is in the boiler section. The hot boiler water heats the hot water.

The temperatures are only examples and may vary between different installations and time of year.

Contact with VVM 310

External information

When the indoor module door is closed, information can be received via an information window and a status lamp.

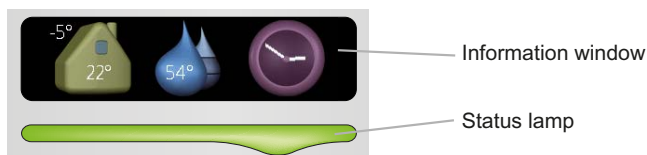

Information window

The information window shows part of the display that is on the display unit (located behind the door to the indoor module). The information window can display different types of information, e.g. temperatures, clock, etc.

You determine what is to be displayed in the information window. Your own combination of information is entered using the display unit. This information is specific to the information window and disappears when the front hatch of the indoor module door is opened.

Instructions on how to set the information window can be found on page 50.

Status lamp

The status lamp indicates the status of the indoor module: continuous green light during normal function, continuous yellow light during activated emergency mode or continuous red light in the event of a deployed alarm.

Alarm management is described on page 56.

Display unit

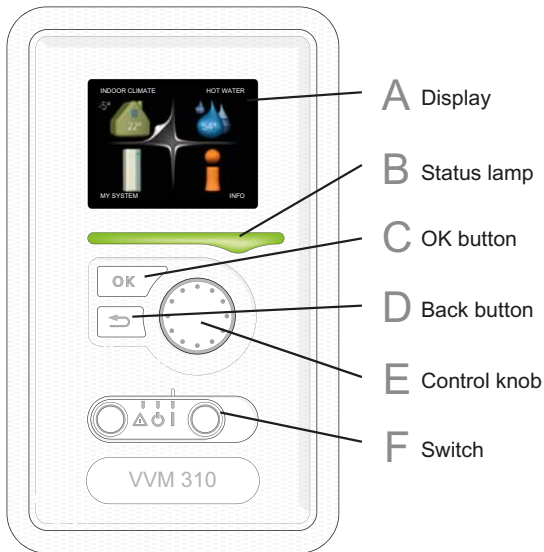

There is a display unit behind the indoor module door, which is used to communicate with VVM 310. Here you:

- switch on, switch off or set the installation to emergency mode.
- set the indoor climate and hot water as well as adjust the installation to your needs.
- receive information about settings, status and events.
- see different types of alarms and receive instructions about how they are to be rectified.

A *Display*

Instructions, settings and operational information are shown on the display. The easy-to-read display and menu system, facilitates navigation between the different menus and options to set the comfort or obtain the information you require.

B *Status lamp*

The status lamp indicates the status of the indoor module. It:

- lights green during normal operation.
- lights yellow in emergency mode.
- lights red in the event of a deployed alarm.

C

OK button

The OK button is used to:

- confirm selections of sub menus/options/set values/page in the start guide.

D

Back button

The back button is used to:

- go back to the previous menu.
- change a setting that has not been confirmed.

E

Control knob

The control knob can be turned to the right or left. You can:

- scroll in menus and between options.
- increase and decrease the values.
- change page in multiple page instructions (for example help text and service info).

F

Switch

The switch assumes three positions:

- On (I)
- Standby (⏻)
- Emergency mode (⚠)

Emergency mode must only be used in the event of a fault on the indoor module. In this mode, the compressor switches off and the immersion heater engages. The indoor module display is not illuminated and the status lamp illuminates yellow.

Menu system

When the door to the indoor module is opened, the menu system's four main menus are shown in the display as well as certain basic information.

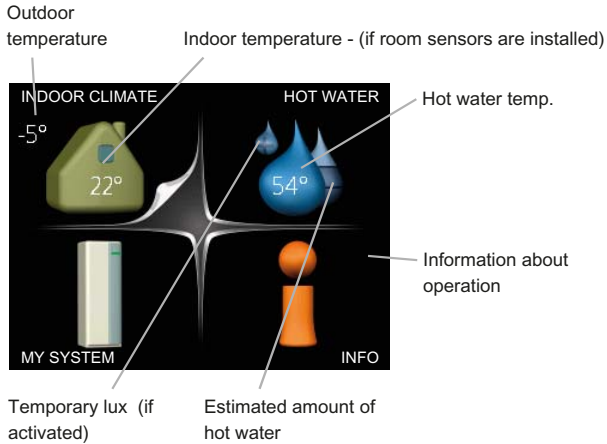

Menu 1

INDOOR CLIMATE

Setting and scheduling the indoor climate. See page 25.

Menu 2

HOT WATER

Setting and scheduling hot water production. See page 36.

Menu 3

INFO

Display of temperature and other operating information and access to the alarm log. See page 40.









Menu 4

MY SYSTEM

Setting time, date, language, display, operating mode etc. See page 43.

Symbols in the display

The following symbols can appear in the display during operation.

Symbol	Description
	This symbol appears by the information sign if there is information in menu 3.1 that you should note.
	<p>These two symbols indicate whether the compressor in the outdoor unit or additional heat is blocked in VVM 310.</p> <p>These can, for example, be blocked depending on which operating mode is selected in menu 4.2, if blocking is scheduled in menu 4.9.5 or if an alarm has occurred that blocks one of them.</p>
	Blocking the compressor.
	Blocking additional heat.
	This symbol appears if lux mode for the hot water is activated.
	This symbol indicates whether VVM 310 has contact with NIBE Uplink™.
	This symbol indicates whether solar heating is active. Accessory needed.
	This symbol indicates whether "holiday setting" is activated in menu 4.7.

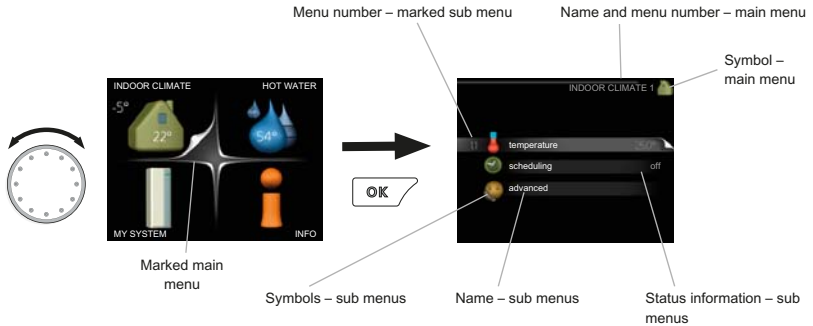

Operation

To move the cursor, turn the control knob to the left or the right. The marked position is brighter and/or has a turned up tab.

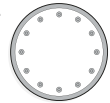

Selecting menu

To advance in the menu system select a main menu by marking it and then pressing the OK button. A new window then opens with sub menus.

Select one of the sub menus by marking it and then pressing the OK button.



Selecting options



Alternative

In an options menu the current selected option is indicated by a green tick. 

To select another option:

1. Mark the applicable option. One of the options is pre-selected (white). 
2. Press the OK button to confirm the selected option. The selected option has a green tick. 

Setting a value



Values to be changed

To set a value:

1. Mark the value you want to set using the control knob.
2. Press the OK button. The background of the value becomes green, which means that you have accessed the setting mode.
3. Turn the control knob to the right to increase the value and to the left to reduce the value.
4. Press the OK button to confirm the value you have set. To change and return to the original value, press the Back button.

01

01

04

04

Use the virtual keyboard

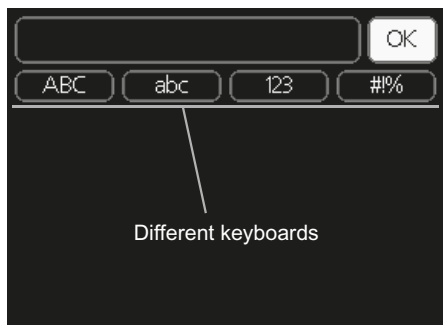

In some menus where text may require entering, a virtual keyboard is available.

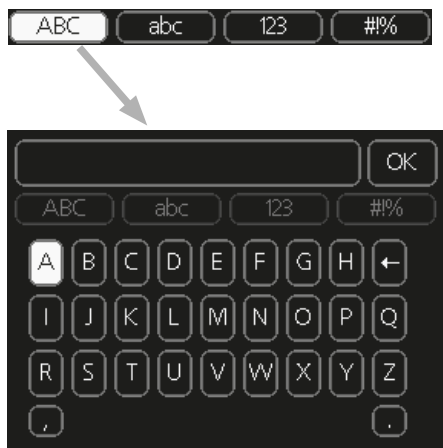

Depending on the menu, you can gain access to different character sets which you can select using the control knob. To change character table, press the Back button. If a menu only has one character set the keyboard is displayed directly.

When you have finished writing, mark "OK" and press the OK button.

Scroll through the windows

A menu can consist of several windows. Turn the control knob to scroll between the windows.

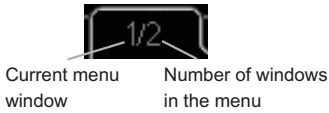

Scroll through the windows in the start guide



Arrows to scroll through window in start guide

1. Turn the control knob until one of the arrows in the top left corner (at the page number) has been marked.
2. Press the OK button to skip between the steps in the start guide.

Help menu



In many menus there is a symbol that indicates that extra help is available.

To access the help text:

1. Use the control knob to select the help symbol.
2. Press the OK button.

The help text often consists of several windows that you can scroll between using the control knob.

Maintenance of VVM 310

Regular checks

Your indoor module is, in principle, maintenance free and therefore requires minimal care after commissioning. On the other hand, it is recommended that you check your installation regularly.

If something unusual occurs, messages about the malfunction appear in the display in the form of different alarm texts. See alarm management on page 56.

Safety valve

The hot water coil's externally mounted safety valve sometimes releases a little water after hot water usage. This is because the cold water, which enters the hot water coil, expands when heated causing the pressure to rise and the safety valve to open.

The function of the safety valve must be checked regularly. You can find the safety valve on the incoming pipe (cold water) to the hot water coil. Perform checks as follows:

1. Open the valve.
2. Check that water flows through the valve.
3. Close the valve.



TIP

The safety valve is not supplied with the indoor module. Contact your installer if you are unsure how one checks the valve.

Saving tips

Your installation produces heat and hot water. This occurs via the control settings you made.

Factors that affect the energy consumption are, for example, indoor temperature, hot water consumption, the insulation level of the house and whether the house has many large window surfaces. The position of the house, e.g. wind exposure is also an affecting factor.

Also remember:

- Open the thermostat valves completely (except in the rooms that are to be kept cooler for various reasons, e.g. bedrooms). The thermostats slow the flow in the heating system, which the indoor module wants to compensate with increased temperatures. It then works harder and consumes more electrical energy.
- You can lower the temperature when away from the house by scheduling "holiday setting" in menu 4.7. See page 51 for instructions.
- If you activate "Hot water Economy", less energy is used.
- You can influence the energy consumption by connecting the indoor module to different supplements such as solar, gas or oil.

Power consumption

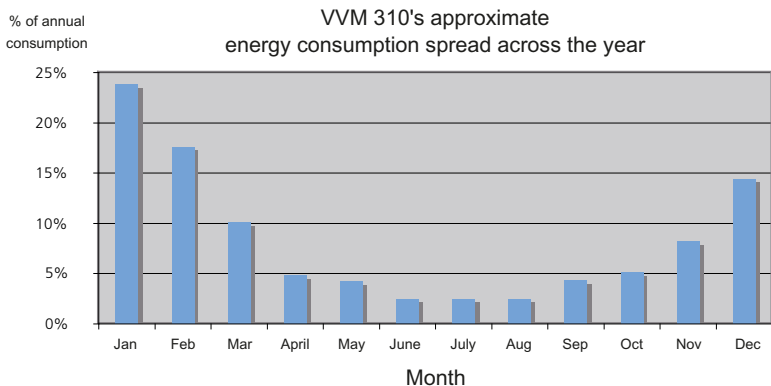

Increasing the indoor temperature one degree increases the energy consumption by approx. 5%.

Domestic electricity

In the past it has been calculated that an average Swedish household has an approximate annual consumption of 5000 kWh domestic electricity/year. In today's society it is usually between 6000-12.000 kWh/year.

Equipment	Normal Output (W)		Approximate annual consumption (kWh)
	Operation	Standby	
Flat-screen (Operation: 5 h/day, Standby: 19 h/day)	200	2	380
Digital box (Operation: 5 h/day, Standby: 19 h/day)	11	10	90
DVD (Operation: 2 h/week)	15	5	45
TV games console (Operation: 6 h/week)	160	2	67
Radio/stereo (Operation: 3 h/day)	40	1	50
Computer incl. screen (Operation: 3 h/day, standby 21 h/day)	100	2	120
Bulb (Operation 8 h/day)	60	-	175
Spot light, Halogen (Operation 8 h/day)	20	-	55
Cooler (Operation: 24 h/day)	100	-	165
Freezer (Operation: 24 h/day)	120	-	380
Oven, hob (Operation: 40 min/day)	1500	-	365
Oven (Operation: 2 h/week)	3000	-	310
Dishwasher, cold water connection (Operation 1 time/day)	2000	-	730
Washing machine (Operation: 1 time/day)	2000	-	730
Tumble drier (Operation: 1 time/day)	2000	-	730
Vacuum cleaner (Operation: 2 h/week)	1000	-	100
Engine block heater (Operation: 1 h/day, 4 months a year)	400	-	50
Passenger compartment heater (Operation: 1 h/day, 4 months a year)	800	-	100

These values are approximate example values.

Example: A family with 2 children live in a house with 1 flat-screen TV, 1 digital box, 1 DVD player, 1 TV games console, 2 computers, 3 stereos, 2 bulbs in the WC, 2 bulbs in the bathroom, 4 bulbs in the kitchen, 3 bulbs outside, a washing machine, tumble drier, fridge, freezer, oven, vacuum cleaner, engine block heater = 6240 kWh domestic electricity/year.

Energy meter

Check the accommodation's energy meter regularly, preferably once a month. This will indicate any changes in power consumption.

Newly built houses usually have twin energy meters, use the difference to calculate your domestic electricity.

New builds

Newly built houses undergo a drying out process for a year. The house can then consume significantly more energy than it would thereafter. After 1-2 years the heating curve should be adjusted again, as well as the heating curve offset and the building's thermostat valves, because the heating system, as a rule, requires a lower temperature once the drying process is complete.

3 VVM 310 – at your service

Set the indoor climate

Overview

Sub-menus

For the menu **INDOOR CLIMATE** there are several sub-menus. Status information for the relevant menu can be found on the display to the right of the menus.

temperature Setting the temperature for the climate system. The status information shows the set values for the climate system.

scheduling Scheduling heating. Status information "set" is displayed if you set a schedule but it is not active at the moment, "holiday setting" is displayed if the vacation schedule is active at the same time as the schedule (the vacation function is prioritised), "active" displays if any part of the schedule is active, otherwise it displays "off".

advanced Setting of heat curve, adjusting with external contact, minimum value for supply temperature, own curve and point offset.

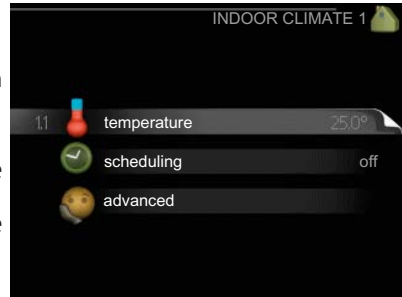

Menu 1.1

temperature

If the house has several climate systems, this is indicated on the display by a thermometer for each system.

Set the temperature (with room sensors installed and activated):

Setting range: 5 - 30 °C
Default value: 20

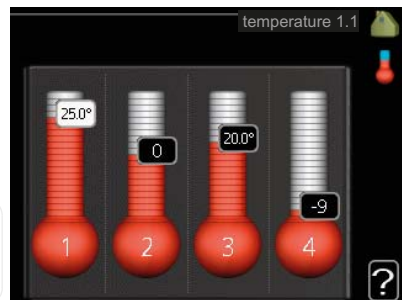

The value in the display appears as a temperature in °C if the heating system is controlled by a room sensor.

To change the room temperature, use the control knob to set the desired temperature in the display. Confirm the new setting by pressing the OK button. The new temperature is shown on the right-hand side of the symbol in the display.

Setting the temperature (without room sensors activated):

Setting range: -10 to +10

Default value: 0

The display shows the set values for heating (curve offset). To increase or reduce the indoor temperature, increase or reduce the value on the display.

Use the control knob to set a new value. Confirm the new setting by pressing the OK button.

The number of steps the value has to be changed to achieve a degree change of the indoor temperature depends on the heating installation. One step is usually enough but in some cases several steps may be required.

Setting the desired value. The new value is shown on the right-hand side of the symbol in the display.



Caution

An increase in the room temperature can be slowed by the thermostats for the radiators or under floor heating. Therefore, open the thermostats fully, except in those rooms where a cooler temperature is required, e.g. bedrooms.



TIP

Wait 24 hours before making a new setting, so that the room temperature has time to stabilise.

If it is cold outdoors and the room temperature is too low, increase the curve slope in menu 1.9.1 by one increment.

If it is cold outdoors and the room temperature is too high, lower the curve slope menu 1.9.1 by one increment.

If it is warm outdoors and the room temperature is too low, increase the value in menu 1.1 by one increment.

If it is warm outdoors and the room temperature is too high, reduce the value in menu 1.1 by one increment.

Menu
1.3

scheduling

In the menu **scheduling** indoor climate (heating) is scheduled for each weekday.

You can also schedule a longer period during a selected period (vacation) in menu 4.7.

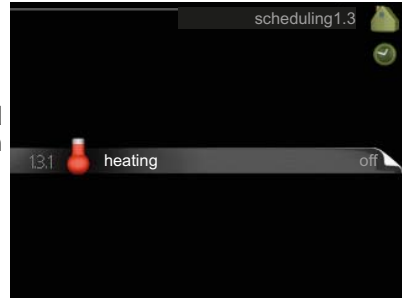

Menu
1.3.1

heating

Increases or decreases in the accommodation temperature can be scheduled here for up to three time periods per day. If a room sensor is installed and activated the desired room temperature (°C) is set during the time period. Without an activated room sensor the desired change is set (of setting in menu 1.1). One step is usually enough to change the room temperature by one degree, but in some cases several steps may be required.

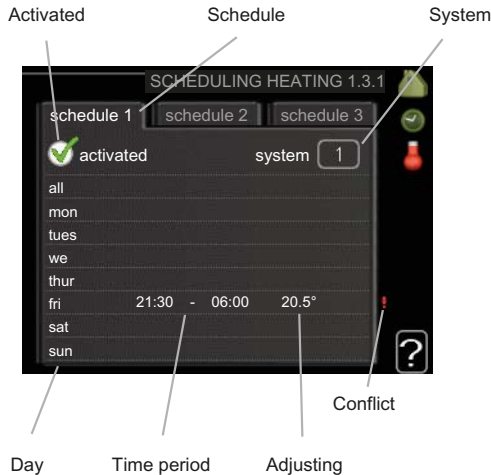

Schedule: The schedule to be changed is selected here.

Activated: Scheduling for the selected period is activated here. Set times are not affected at deactivation.

System: Which climate system the schedule is for is selected here. This alternative is only displayed if more than one climate system is present.

Day: Select which day or days of the week the schedule is to apply to here. To remove the scheduling for a particular day, the time for that day must be reset by setting the start time to the same as the stop time. If the line "all" is used, all days in the period are set for these times.

Time period: The start and stop time for the selected day for scheduling are selected here.

Adjusting: How much the heating curve is to be offset in relation to menu 1.1 during scheduling is set here. If the room sensor is installed the desired room temperature is set in °C.

Conflict: If two settings conflict with each other a red exclamation mark is displayed.



TIP

If you wish to set similar scheduling for every day of the week start by filling in "all" and then changing the desired days.



Caution

If the stop time is before the start time it means that the period extends past midnight. Scheduling always starts on the date that the start time is set for.

Changes of temperature in accommodation take time. For example, short time periods in combination with underfloor heating will not give a noticeable difference in room temperature.

Menu 1.9

advanced

Menu **advanced** has orange text and is intended for the advanced user. This menu has several sub-menus.

heating curve Setting the heating curve slope.

external adjustment Setting the heat curve offset when the external contact is connected.

min. flow line temp. Setting minimum permitted flow line temperature.

room sensor settings Settings regarding the room sensor.

own curve Setting own heat curve.

point offset Setting the offset of the heating curve at a specific outdoor temperature.

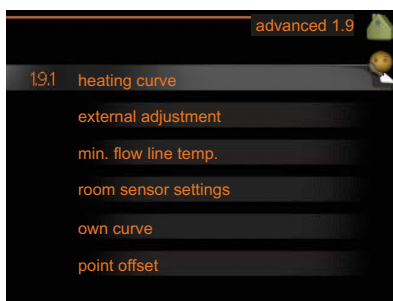

heating curve

heating curve

Setting range: 0 - 15

Default value: 9

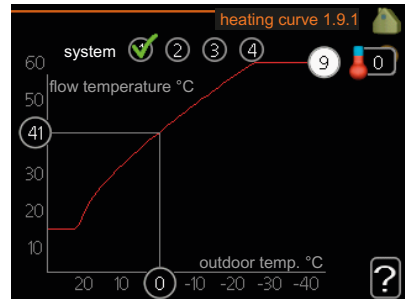

In the menu **heating curve** the so-called heating curve for your house can be viewed. The task of the heating curve is to give an even indoor temperature, regardless of the outdoor temperature, and thereby energy efficient operation. It is from this heating curve that the indoor module's control computer determines the temperature of the water to the heating system, flow line temperature, and therefore the indoor temperature. You can select heating curve and read off how the flow line temperature changes at different outdoor temperatures here.

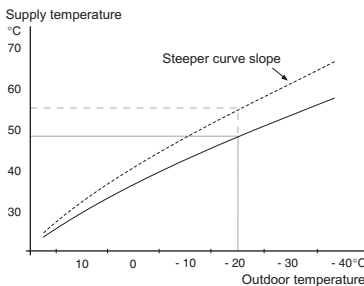

Curve coefficient

The slope of the heating curve indicates how many degrees the supply temperature is to be increased/reduced when the outdoor temperature drops/increases. A steeper slope means a higher supply temperature at a certain outdoor temperature.

The optimum slope depends on the climate conditions in your location, if the house has radiators or under floor heating and how well insulated the house is.

The heating curve is set when the heating installation is installed, but may need adjusting later. Thereafter the heating curve should not need further adjustment.



Caution

In the event of making fine adjustments for the indoor temperature, the heat curve must be offset up or down instead, this is done in menu 1.1 **temperature**.

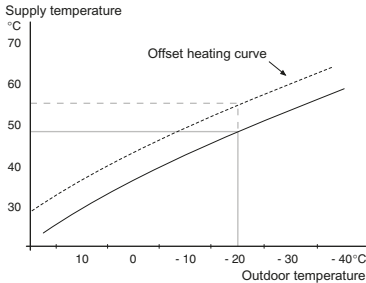

Curve offset

An offset of the heating curve means that the supply temperature changes as much for all the outdoor temperatures, e.g. that a curve offset of +2 steps increases the supply temperature by 5 °C at all outdoor temperatures.

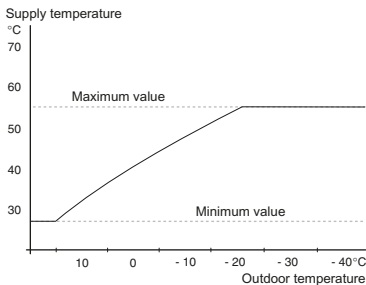

Flow line temperature– maximum and minimum values

Because the flow line temperature cannot be calculated higher than the set maximum value or lower than the set minimum value the heating curve flattens out at these temperatures.



Caution

Underfloor heating systems are normally **max flow line temperature** set between 35 and 45 °C.

Check the max temperature for your floor with your installer/floor supplier.

The figure at the end of the curve indicates the curve slope. The figure beside the thermometer gives the curve offset. Use the control knob to set a new value. Confirm the new setting by pressing the OK button.

Curve 0 is an own heating curve created in menu 1.9.7.



To select another heat curve (slope):

NOTE

If you only have one heating system, the number of the curve is already marked when the menu window opens.

1. Select the system (if more than one) for which the heat curve is to be changed.
2. When the system selection has been confirmed the heat curve number is marked.
3. Press the OK button to access the setting mode
4. Select a new heating curve. The heat curves are numbered from 0 to 15, the greater the number, the steeper the slope and the greater the supply temperature. Heating curve 0 means that **own curve** (menu 1.9.7) is used.
5. Press the OK button to exit the setting.

To read off a heating curve:

1. Turn the control knob so that the ring on the shaft with the outdoor temperature is marked.
2. Press the OK button.
3. Follow the grey line up to the heat curve and out to the left to read off the value for the supply temperature at the selected outdoor temperature.
4. You can now select to take read outs for different outdoor temperatures by turning the control knob to the right or left and read off the corresponding flow temperature.
5. Press the OK or Back button to exit read off mode.



TIP

Wait 24 hours before making a new setting, so that the room temperature has time to stabilise.

If it is cold outdoors and the room temperature is too low, increase the curve slope by one increment.

If it is cold outdoors and the room temperature is too high, lower the curve slope by one increment.

If it is warm outdoors and the room temperature is too low, increase the curve offset by one increment.

If it is warm outdoors and the room temperature is too high, lower the curve offset by one increment.

Menu
1.9.2

external adjustment

climate system

Setting range: -10 to +10 or desired room temperature if the room sensor is installed.

Default value: 0

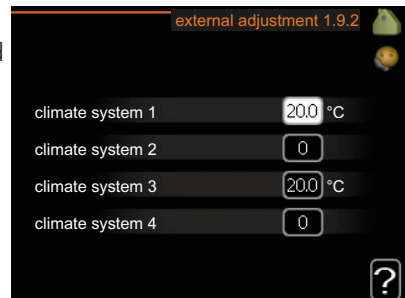

Connecting an external contact, for example, a room thermostat or a timer allows you to temporarily or periodically raise or lower the room temperature. When the contact is on, the heat curve offset is changed by the number of steps selected in the menu. If a room sensor is installed and activated the desired room temperature (°C) is set.

If there is more than one climate system the setting can be made separately for each system.

min. flow line temp.

climate system

Setting range: 5-70 °C

Default value: 20 °C

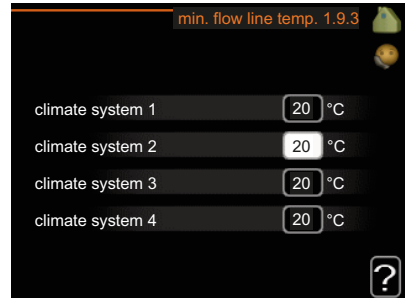

Set the minimum temperature on the supply temperature to the climate system. This means that VVM 310 never calculates a temperature lower than that set here.

If there is more than one climate system the setting can be made separately for each system.



TIP

The value can be increased if you have, for example, a cellar that you always want to heat, even in summer.

You may also need to increase the value in "stop heating" menu 4.9.2 "auto mode setting".

room sensor settings

factor system

Setting range: 0.0 - 6.0

Default value: 2.0

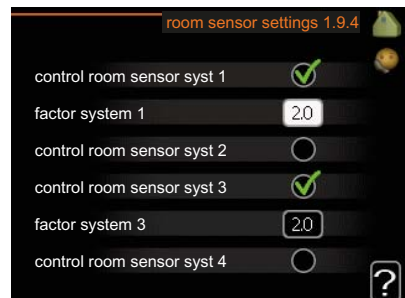

Room sensors to control the room temperature can be activated here.

Here you can set a factor that determines how much the supply temperature is to be affected by the difference between the desired room temper-

ature and the actual room temperature. A higher value gives a greater change of the heating curve's set offset.

If several climate systems are installed the above settings can be made for the relevant systems.

Menu
1.9.7

own curve

supply temperature

Setting range: 0 – 80 °C

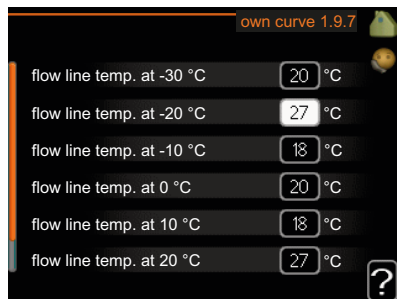

You can create your own heating curve here, if there are special requirements, by setting the desired supply temperatures for different outdoor temperatures.



Caution

Curve 0 in menu 1.9.1 must be selected for this curve to apply.

Menu
1.9.8

point offset

outdoor temp. point

Setting range: -40 – 30 °C

Default value: 0 °C

change in curve

Setting range: -10 – 10 °C

Default value: 0 °C

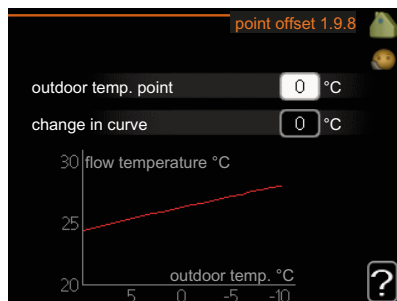

Select a change in the heating curve at a certain outdoor temperature here. One step is usually enough to change the room temperature by one degree, but in some cases several steps may be required.

The heat curve is affected at ± 5 °C from set outdoor temp. point.

It is important that the correct heating curve is selected so that the room temperature is experienced as even.



TIP

If it is cold in the house, at, for example $-2\text{ }^{\circ}\text{C}$, "outdoor temp. point" is set to "-2" and "change in curve" is increased until the desired room temperature is maintained.



Caution

Wait 24 hours before making a new setting, so that the room temperature has time to stabilise.

Set the hot water capacity

Overview

Sub-menus

For the menu **HOT WATER** there are several sub-menus. Status information for the relevant menu can be found on the display to the right of the menu.

temporary lux Activation of temporary increase in the hot water temperature. Status information displays "off" or what length of time of the temporary temperature increase remains.

comfort mode Setting hot water comfort. The status information displays what mode is selected, "economy", "normal" or "luxury".

scheduling Scheduling hot water comfort. Status information "set" displays if any part of the schedule is active at present, "holiday setting" displays if vacation setting is in progress (menu 4.7), otherwise it displays "off".

advanced Setting hot water circulation (accessory is required)



Menu
2.1

temporary lux

Setting range: 3, 6 and 12 hours and mode "off"

Default value: "off"

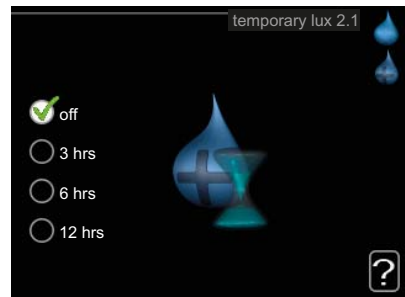

When hot water requirement has temporarily increased this menu can be used to select an increase in the hot water temperature to lux mode for a selectable time.



Caution

If comfort mode "luxury" is selected in menu 2.2 no further increase can be carried out.

The function is activated immediately when a time period is selected and confirmed using the OK button. The remaining time for the selected setting is shown to the right.

When the time has run out VVM 310 returns to the mode set in menu 2.2. Select "off" to switch off **temporary lux**.

Menu
2.2

comfort mode

Setting range: economy, normal,
luxury

Default value: normal



The difference between the selectable modes is the temperature of the hot tap water. Higher temperature means that the hot water lasts longer.

economy: This mode gives less hot water than the other, but is more economical. This mode can be used in smaller households with a small hot water requirement.

normal: Normal mode gives a larger amount of hot water and is suitable for most households.

luxury: Lux mode gives the greatest possible amount of hot water. In this mode, the immersion heater, as well as the compressor, is used to heat hot water, which may increase operating costs.

Menu
2.3

scheduling

What hot water comfort the indoor module is to work with can be scheduled here for up to two different time periods per day.

Scheduling is activated/deactivated by ticking/unticking "activated". Set times are not affected at deactivation.

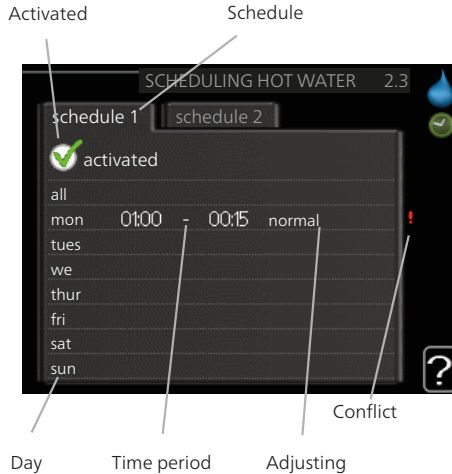

Schedule: The schedule to be changed is selected here.

Activated: Scheduling for the selected period is activated here. Set times are not affected at deactivation.

Day: Select which day or days of the week the schedule is to apply to here. To remove the scheduling for a particular day, the time for that day must be reset by setting the start time to the same as the stop time. If the line "all" is used, all days in the period are set for these times.

Time period: The start and stop time for the selected day for scheduling are selected here.

Adjusting: Set the hot water comfort that is to apply during scheduling here.

Conflict: If two settings conflict with each other a red exclamation mark is displayed.



TIP

If you wish to set similar scheduling for every day of the week start by filling in "all" and then changing the desired days.



Caution

If the stop time is earlier in the day than the start time it means that the period extends past midnight.

Scheduling always starts on the date that the start time is set for.

Menu
2.9

advanced

Menu **advanced** has orange text and is intended for the advanced user. This menu has a sub-menu.

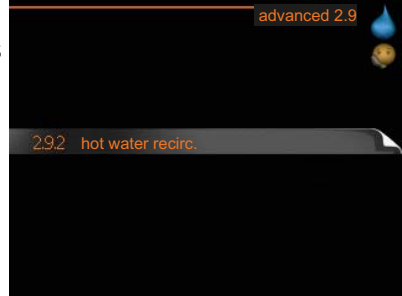

Menu
2.9.2

hot water recirc.

operating time

Setting range: 1 - 60 min

Default value: 60 min

downtime

Setting range: 0 - 60 min

Default value: 0 min

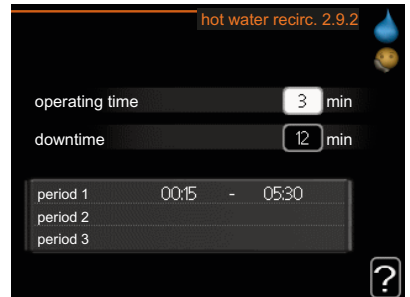

Set the hot water circulation for up to three periods per day here. During the set periods the hot water circulation pump will run according to the settings above.

"operating time" decide how long the hot water circulation pump must run per operating instance.

"downtime" decide how long the hot water circulation pump must be stationary between operating instances.

Get information

Overview

Sub-menus

For the menu **INFO** there are several sub-menus. No settings can be made in these menus, they just display information. Status information for the relevant menu can be found on the display to the right of the menu.

service info shows temperature levels and settings in the installation.

compressor info shows operating times, number of starts etc for the compressor in the heat pump.

add. heat info displays information about the addition's operating times etc.

alarm log shows the latest alarms.

indoor temp. log the average temperature indoors week by week during the past year.



Menu
3.1

service info

Information about the heat pump's current operating status (e.g. current temperatures, information from the flow meter etc.) can be obtained here. No changes can be made.

The information is on several pages. Turn the control knob to scroll between the pages.

A QR code appears on one side. This QR code indicates serial number, product name and limited operating data.

Symbols in this menu:



Compressor



Addition



Cooling



Heating



Hot water



Pool



Heating medium pump (orange)

Menu
3.2

compressor info

Information about the compressor's operating status and statistics can be obtained here. No changes can be made.

The information is on several pages. Turn the control knob to scroll between the pages.

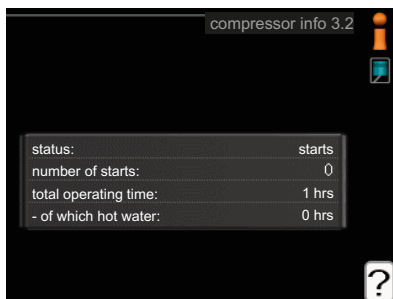

Menu
3.3

add. heat info

Information about the additional heat settings, operating status and statistics can be obtained here. No changes can be made.

The information is on several pages. Turn the control knob to scroll between the pages.

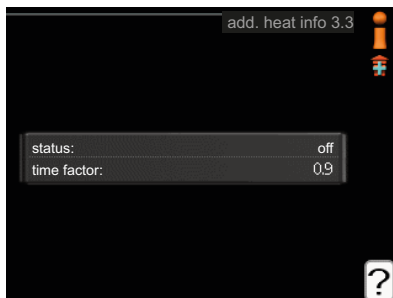

alarm log

To facilitate fault-finding the installation's operating status at alarm alerts is stored here. You can see information for the 10 most recent alarms.

To view the run status in the event of an alarm, mark the alarm and press the OK button.

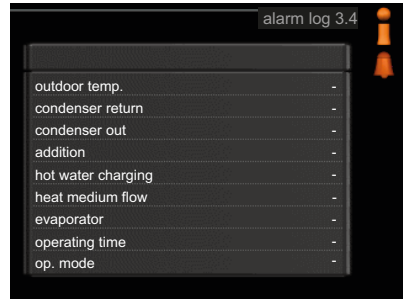

Information about an alarm.

indoor temp. log

Here you can see the average temperature indoors week by week during the past year. The dotted line indicates the annual average temperature.

The average outdoor temperature is only shown if a room temperature sensor/room unit is installed.

To read off an average temperature

1. Turn the control knob so that the ring on the shaft with the week number is marked.
2. Press the OK button.
3. Follow the grey line up to the graph and out to the left to read off the average indoor temperature at the selected week.
4. You can now select to take read outs for different weeks by turning the control knob to the right or left and read off the average temperature.
5. Press the OK or Back button to exit read off mode.

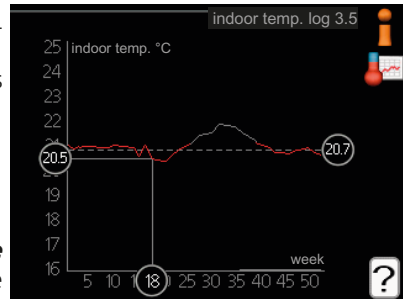

Adjust the indoor module

Overview

Sub-menus

For the menu **MY SYSTEM** there are several sub-menus. Status information for the relevant menu can be found on the display to the right of the menu.

plus functions Settings applying to any installed extra functions in the heating system.

op. mode Activation of manual or automatic operating mode. The status information shows the selected operating mode.

my icons Settings regarding which icons in the indoor module's user interface that are to appear on the hatch when the door is closed.

time & date Setting current time and date.

language Select the language for the display here. The status information shows the selected language.

holiday setting Vacation scheduling heating and hot water comfort. Status information "set" is displayed if you set a vacation schedule but it is not active at the moment, "active" is displayed if any part of the vacation schedule is active, otherwise it displays " off".

advanced Settings of indoor module work mode.



Menu
4.1

plus functions

Settings for any additional functions installed in VVM 310 can be made in the sub menus.

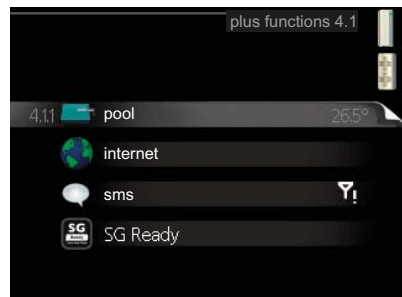

pool (accessory is required)

start temp

Setting range: 5.0 - 80.0 °C

Default value: 22.0 °C

stop temperature

Setting range: 5.0 - 80.0 °C

Default value: 24.0 °C



Select whether the pool control is to be activated and within what temperatures (start and stop temperature) pool heating must occur.

When the pool temperature drops below the set start temperature and there is no hot water or heating requirement, VVM 310 starts pool heating.

Untick "activated" to switch off the pool heating.



Caution

The start temperature cannot be set to a value that is higher than the stop temperature.

internet

Here you make settings for connecting VVM 310 to the internet.



NOTE

For these functions to work the network cable must be connected.

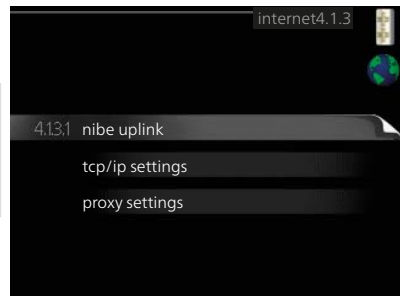

nibe uplink

Here you can manage the installation's connection to NIBE Uplink™ (<http://www.nibeuplink.com>) and see the number of users connected to the installation via the internet.

A connected user has a user account in NIBE Uplink™ which have been given permission to control and/or monitor your installation.

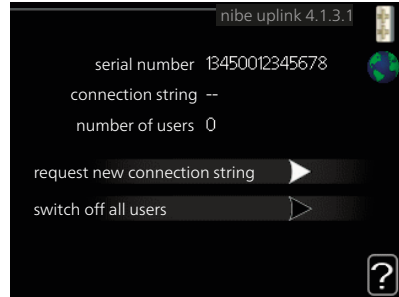

Request new connection string

To connect a user account on NIBE Uplink™ to your installation, you must request a unique connection string.

1. Mark "request new connection string" and press the OK button.
2. The installation now communicates with NIBE Uplink™ to create a connection string.
3. When a connection string has been received, it is shown in this menu at "connection string" and is valid for 60 minutes.

Disconnect all users

1. Mark "switch off all users" and press the OK button.
2. The installation now communicates with NIBE Uplink™ to release your installation from all connected users via the internet.



NOTE

After disconnecting all users none of them can monitor or control your installation via NIBE Uplink™ without requesting a new connection string.

tcp/ip settings

You can set TCP/IP settings for your installation here.

Automatic setting (DHCP)

1. Tick "automatic". The installation now receives the TCP/IP settings using DHCP.
2. Mark "confirm" and press the OK button.



Manual setting

1. Untick "automatic", you now have access to several setting options.
2. Mark "ip-address" and press the OK button.

3. Enter the correct details via the virtual keypad.
4. Mark "OK" and press the OK button.
5. Repeat 1 - 3 for "net mask", "gateway" and "dns".
6. Mark "confirm" and press the OK button.



Caution

The installation cannot connect to the internet without the correct TCP/IP settings. If unsure about applicable settings use the automatic mode or contact your network administrator (or similar) for further information.



TIP

All settings made since opening the menu can be reset by marking "reset" and pressing the OK button.

Menu 4.1.3.9

proxy settings

You can set proxy settings for your installation here.

Proxy settings are used to give connection information to a intermediate server (proxy server) between the installation and Internet. These settings are primarily used when the installation connects to the Internet via a company network. The installation supports proxy authentication of the HTTP Basic and HTTP Digest type.

If unsure about applicable settings use the preset settings or contact your network administrator (or similar) for further information.

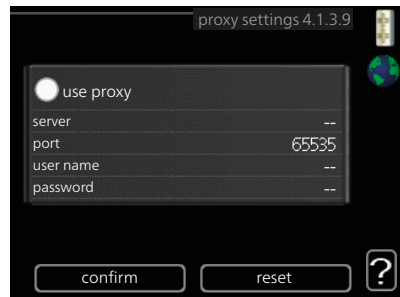

Setting

1. Tick "use proxy" if you do not want to use a proxy.
2. Mark "server" and press the OK button.
3. Enter the correct details via the virtual keypad.
4. Mark "OK" and press the OK button.
5. Repeat 1 - 3 for "port", "user name" and "password".
6. Mark "confirm" and press the OK button.



TIP

All settings made since opening the menu can be reset by marking "reset" and pressing the OK button.

Menu
4.1.4

sms (accessory is required)

Make settings for the accessory SMS 40 here.

Add the mobile numbers that are to have access to change and receive status information from the indoor module. Mobile numbers must include country code e.g. +46 XXXXXXXX.

If you want to receive an SMS message in the event of the alarm mark the box to the right of the telephone number.

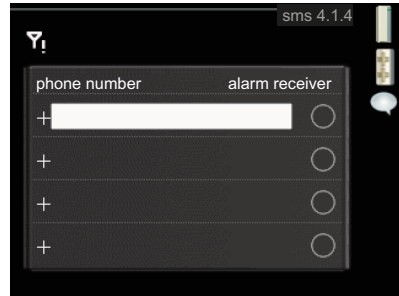

NOTE

Telephone numbers provided must be able to receive SMS messages.

Menu
4.1.5

SG Ready

This function can only be used in mains networks that support the "SG Ready"-standard (Germany).

Make settings for the function "SG Ready" here.

affect room temperature

Here you set whether room temperature should be affected when activating "SG Ready".

With low price mode of "SG Ready" the parallel offset of the indoor temperature is increased by "+1". If a room sensor is installed and activated, the desired room temperature increases by 1 °C.

With over capacity mode of "SG Ready" the parallel offset for the indoor temperature is increased by "+2". If a room sensor is installed and activated, the desired room temperature increases by 2 °C.

affect hot water

Here you set whether the temperature of the hot water should be affected when activating "SG Ready".



With low price mode on "SG Ready" the stop temperature of the hot water is set as high as possible at only compressor operation (immersion heater not permitted).

With over capacity mode of "SG Ready" the hot water is set to "luxury" (immersion heater permitted).

affect cooling (accessories required)

Here you set whether room temperature during cooling operation should be affected when activating "SG Ready".

With low price mode of "SG Ready" and cooling operation the indoor temperature is not affected.

With over capacity mode of "SG Ready" and cooling operation the parallel offset for the indoor temperature is reduced by "-1". If a room sensor is installed and activated, the desired room temperature decreases by 1 °C.

affect pool temperature (accessories required)

Here you set whether pool temperature should be affected when activating "SG Ready".

With low price mode of "SG Ready" the desired pool temperature (start and stop temperature) is increased by 1 °C.

With over capacity mode of "SG Ready" the desired pool temperature (start and stop temperature) is increased by 2 °C.



NOTE

The function must be connected and activated in your VVM 310.

Menu
4.2

op. mode

op. mode

Setting range: auto, manual, add. heat only

Default value: auto

functions

Setting range: compressor, addition, heating, cooling



The indoor module operating mode is usually set to "auto". It is also possible to set the indoor module to "add. heat only", but only when an addition is used, or "manual" the select yourself what functions are to be permitted.

Change the operating mode by marking the desired mode and pressing the OK button. When an operating mode is selected it shows what in the indoor module is permitted (crossed out = not permitted) and selectable alternatives to the right. To select selectable functions that are permitted or not you mark the function using the control knob and press the OK button.

Operating mode auto

In this operating mode the indoor module automatically selects what functions are permitted.

Operating mode manual

In this operating mode you can select what functions are permitted. You cannot deselect "compressor" in manual mode.

Operating mode add. heat only

In this operating mode the compressor is not active and only additional heating is used.



Caution

If you choose mode "add. heat only" the compressor is deselected and there is a higher operating cost.



Caution

You cannot change from only additional heat if you do not have a slave connected (see Menu 5.2.2).

Functions

"**compressor**" is that which produces heating and hot water for the accommodation. If "compressor" is deselected, a symbol in the main menu on the symbol for the indoor module. You cannot deselect "compressor" in manual mode.

"**addition**" is what helps the compressor to heat the accommodation and/or the hot water when it cannot manage the whole requirement alone.

"**heating**" means that you get heat in the accommodation. You can deselect the function when you do not wish to have heating running.

"**cooling**" means that you get cooling in the accommodation in hot weather. You can deselect the function when you do not wish to have the cooling running. This alternative requires an accessory for cooling or if the heat pump has a built in function for cooling and is activated in the menu.

Menu
4.3

my icons

You can select what icon should be visible when the door to VVM 310 is closed. You can select up to 3 icons. If you select more, the ones you selected first will disappear. The icons are displayed in the order you selected them.



Menu
4.4

time & date

Set time and date, display mode and time zone here.



TIP

Time and date are set automatically if the heat pump is connected to NIBE Uplink™. To obtain the correct time, the time zone must be set.



Menu
4.6

language

Choose the language that you want the information to be displayed in here.

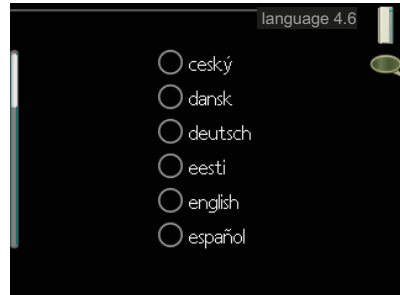

holiday setting

To reduce energy consumption during a holiday you can schedule a reduction in heating and hot water temperature. Cooling, pool and solar panel cooling can also be scheduled if the functions are connected.

If a room sensor is installed and activated the desired room temperature (°C) is set during the time period. This setting applies to all climate systems with room sensors.

If a room sensor is not activated, the desired offset of the heating curve is set. This setting applies to all climate systems without room sensors. One step is usually enough to change the room temperature by one degree, but in some cases several steps may be required.

Vacation scheduling starts at 00:00 on the start date and stops at 23:59 on the stop date.

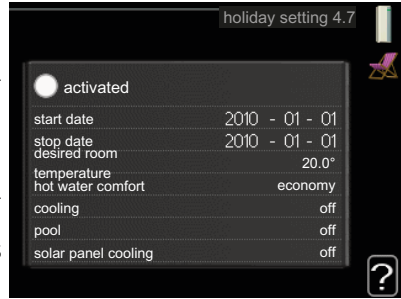

TIP

Complete holiday setting about a day before your return so that room temperature and hot water have time to regain usual levels.



TIP

Set the vacation setting in advance and activate just before departure in order to maintain the comfort.

advanced

Menu **advanced** has orange text and is intended for the advanced user. This menu has several sub-menus.

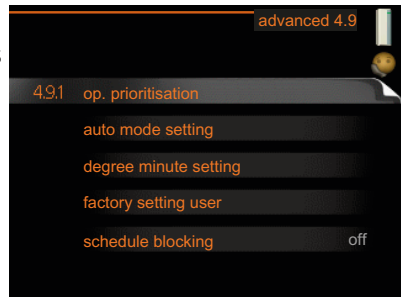

op. prioritisation

op. prioritisation

Setting range: 0 to 180 min

Default value: 30 min

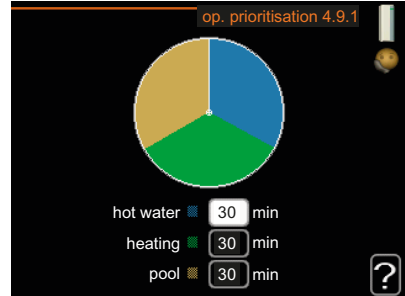

Choose here how long the installation should work with each requirement if there are several requirements at the same time. If there is only one requirement the installation only works with that requirement.

The indicator marks where in the cycle the installation is.

If 0 minutes is selected it means that requirement is not prioritised, but will only be activated when there is no other requirement.

auto mode setting

start cooling

Setting range: -20 – 40 °C

Default value: 25

stop heating

Setting range: -20 – 40 °C

Default values: 17

stop additional heat

Setting range: -25 – 40 °C

Default values: 5

filtering time

Setting range: 0 – 48 h

Default value: 24 h

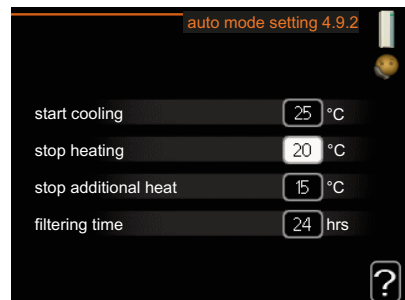

When the operating mode is set to "auto", the indoor module selects when start and stop of additional heat and heat production is permitted, dependent on the average outdoor temperature. If accessories for cooling are present or if the heat pump has the integrated cooling function and it is activated in the menu you can also select the start temperature for cooling.

Select the average outdoor temperatures in this menu.

You can also set the time over which (filtering time) the average temperature is calculated. If you select 0, the present outdoor temperature is used.



Caution

It cannot be set "stop additional heat" higher than "stop heating".



Caution

In systems where heating and cooling share the same pipes "stop heating" cannot be set higher than "start cooling".

Menu
4.9.3

degree minute setting

current value

Setting range: -3000 – 3000

start compressor

Setting range: -1000 – -30

Default value: -60

start diff additional heat

Setting range: 100 – 1000

Default value: 700

diff. between additional steps

Setting range: 0 – 1000

Default value: 100

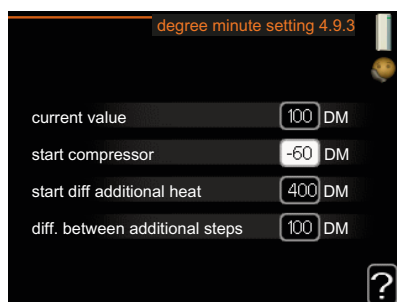

Degree minutes are a measurement of the current heating requirement in the house and determine when the compressor respectively additional heat will start/stop.



Caution

Higher value on "start compressor" gives more compressor starts, which increases wear in the compressor. Too low value can give uneven indoor temperatures.

factory setting user

All settings that are available to the user (including advanced menus) can be reset to default values here.



Caution

After factory setting, personal settings such as heating curves must be reset.

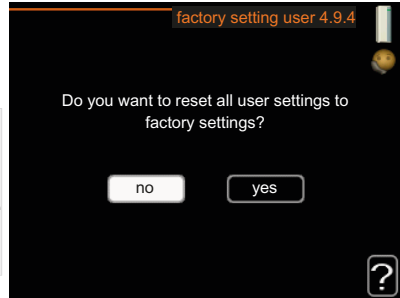

schedule blocking

The compressor and/or addition in the indoor module can be scheduled to be blocked for up to two different time periods here.

When scheduling is active the relevant blocking symbol is shown in the main menu on the symbol for the indoor module.

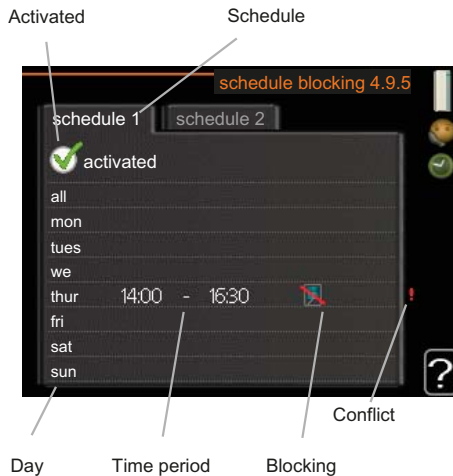

Schedule: The period to be changed is selected here.

Activated: Scheduling for the selected period is activated here. Set times are not affected at deactivation.

Day: Select which day or days of the week the schedule is to apply to here. To remove the scheduling for a particular day, the time for that day must be reset by setting the start time to the same as the stop time. If the line "all" is used, all days in the period are set for these times.

Time period: The start and stop time for the selected day for scheduling are selected here.

Blocking: The desired blocking is selected here.

Conflict: If two settings conflict with each other a red exclamation mark is displayed.



Blocking the compressor in the outdoor unit.



Blocking additional heat.



TIP

If you wish to set similar scheduling for every day of the week start by filling in "all" and then changing the desired days.



Caution

If the stop time is before the start time it means that the period extends past midnight.

Scheduling always starts on the date that the start time is set for.



Caution

Long term blocking can cause reduced comfort and operating economy.

4 Disturbances in comfort

In most cases, the indoor module notes operational interference (operational interference can lead to disturbance in comfort) and indicates this with alarms and shows action instructions in the display.

Info-menu

All the indoor module measurement values are gathered under menu 3.1 in the indoor module menu system. Looking through the values in this menu can often simplify finding the fault source.

Manage alarm

In the event of an alarm, some kind of malfunction has occurred, which is indicated by the status lamp changing from green continuously to red continuously. In addition, an alarm bell appears in the information window.

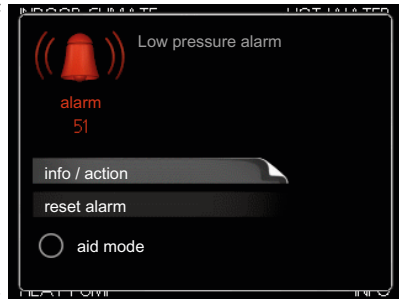

Alarm

In the event of an alarm with a red status lamp a malfunction has occurred that the indoor module cannot remedy itself. In the display, by turning the control knob and pressing the OK button, you can see the type of alarm it is and reset it. You can also choose to set the indoor module to aid mode.

info / action Here you can read what the alarm means and receive tips on what you can do to correct the problem that caused the alarm.

reset alarm In most cases it is enough to select "reset alarm" to correct the problem that caused the alarm. If a green light illuminates after selecting "reset alarm" the alarm has been remedied. If a red light is still visible and a menu called "alarm" is visible in the display, the problem that caused the alarm remains. If the alarm disappears and then returns, contact your installer.

aid mode "aid mode" is a type of emergency mode. This means that the indoor module produces heat and/or hot water despite there being some kind of problem. This can mean that the indoor module's compressor is not running. In this case the immersion heater produces heat and/or hot water.

**Caution**

Selecting "aid mode" is not the same as correcting the problem that caused the alarm. The status lamp will therefore continue to be red.

If the alarm does not reset, contact your installer for suitable remedial action.

**NOTE**

Always communicate the product's serial number (14 digits) when reporting a fault.

Troubleshooting

If the operational interference is not shown in the display the following tips can be used:

Basic actions

Start by checking the following possible fault sources:

- The switch's position.
- Group and main fuses of the accommodation.
- The property's earth circuit breaker.
- Correctly set load monitor (if installed).

Low hot water temperature or a lack of hot water

- Too high domestic water flow.
 - Reduce the domestic water flow, see diagram of hot water capacity in the installation manual.
- Indoor module in incorrect operating mode.
 - If mode "manual" is selected, select "addition".
- Large hot water consumption.
 - Wait until the hot water has heated up. Temporarily increased hot water capacity (temporary lux) can be activated in menu 2.1.
- Too low hot water setting.
 - Enter menu 2.2 and select a higher comfort mode.

Low room temperature

- Closed thermostats in several rooms.
- Indoor module in incorrect operating mode.
 - Enter menu 4.2. If mode "auto" is selected, select a higher value on "stop heating" in menu 4.9.2.
 - If mode "manual" is selected, select "heating". If this is not enough, select "addition".
- Too low set value on the automatic heating control.
 - Enter menu 1.1 "temperature" and adjust the offset of the heating curve. If the room temperature is only low in cold weather the curve slope in menu 1.9.1 "heating curve" needs adjusting up.
- "Holiday mode" activated in menu 4.7.
 - Enter menu 4.7 and select "Off".
- External switch for changing the room heating activated.
 - Check any external switches.
- Air in the climate system.
 - Vent the climate system

- Closed valves to the climate system.
 - Open the valves.

High room temperature

- Too high set value on the automatic heating control.
 - Enter menu 1.1 (temperature) and adjust the heat curve offset downwards. If the room temperature is only high in cold weather the curve slope in menu 1.9.1 (heating curve) needs to be adjusted down.
- External switch for changing the room heating activated.
 - Check any external switches.

Low system pressure

- Not enough water in the climate system.
 - Top up the water in the climate system.

The compressor does not start

- There is no heating requirement.
 - The indoor module does not call on heating nor hot water.
- Temperature conditions tripped.
 - Wait until the temperature condition has been reset.
- Minimum time between compressor starts has not been reached.
 - Wait 30 minutes and check if the compressor has started.
- Alarm tripped.
 - Follow the display instructions.

5 Technical data

Detailed technical specifications for this product can be found in the installation manual (www.nibe.eu).

6 Glossary

Additional heat:

The additional heat is the heat produced in addition to the heat supplied by the compressor in your heat pump. Additional heaters can be for example, immersion heater, electric heater, solar power system, gas/oil/pellet/wood burner or district heating.

Buffer vessel

A buffer vessel increases the system volume and removes the unwanted temperature variations that can otherwise be sent out on the climate system. This ensure the running of the heat pump and reduces the heat spikes that could otherwise be heard from the climate system.

Calculated flow line temperature

The temperature that the indoor module calculates that the heating system requires for an optimum accommodation temperature. The colder the outdoor temperature, the higher the calculated supply temperature.

Charge pump

See "Circulation pump".

Circulation pump

Pump that circulates liquid in a pipe system.

Climate system

Climate systems can also be called heating systems. The building is heated using radiators, under floor coils or convector fans.

Compressor

Compresses the gas state refrigerant. When the refrigerant is compressed, the pressure and the temperature increase.

Condenser

Heat exchanger where the hot gas state refrigerant condenses (cooled and becomes a liquid) and releases heat energy to the house heating and hot water systems.

Convector

Works in the same way as a radiator, but with the difference that the air is blown out.

Disturbances in comfort

Disturbances in comfort are undesirable changes to the hot water/indoor comfort, for example when the temperature of the hot water is too low or if the indoor temperature is not at the desired level.

An operational interruption in the indoor module can sometimes be noticed as disturbances in comfort.

In most cases, the indoor module notes operational interference and indicates this with alarms and shows instructions on how to rectify it in the display.

Domestic hot water

The water one showers in for example.

DUT, dimensioned outdoor temperature

The dimensioned outdoor temperature differs depending on where you live. The lower the dimensioned outdoor temperature, the lower the value should be selected on "selecting a heat curve".

Electrical addition

This is the electricity that, for example, an internal immersion heater uses to cover the heating demand that the heat pump cannot manage.

Emergency mode

A mode that can be selected using the switch in the event of a fault, which means that the indoor module stops. When the indoor module is in emergency mode, the building and/or hot water is heated using an immersion heater.

Evaporator

Heat exchanger where the refrigerant evaporates by retrieving heat energy from the air which then cools.

Expansion vessel

Vessel with heating medium fluid with the task of equalising the pressure in the heating medium system.

Flow pipe

The line in which the heated water is transported from the indoor module out to the house's climate system (radiators/heating coils).

Heat exchanger

Device that transfers heat energy from one medium to another without mixing mediums. Examples of different heat exchangers are evaporators and condensers.

Heating curve

The heating curve determines which heat the indoor module is to produce depending on the temperature outdoors. If a high value is selected, this tells the indoor module that it must supply a lot of heat when it is cold outdoors in order to achieve a warm indoor temperature.

Heating medium

Hot liquid, usually normal water, which is sent from the indoor module to the house climate system and makes the accommodation warm. The heating medium also heats the charge coil with the hot water.

Hot water coil

A hot water coil heats the domestic hot water (tap water) in the indoor module with heating water (heating medium).

Outside sensor

A sensor that is located outdoors. This sensor tells the indoor module how hot it is outdoors.

Radiator

Another word for heating element. They must be filled with water in order to be used with VVM 310.

Refrigerant

Substance that circulates around a closed circuit in the heat pump and that, through pressure changes, evaporates and condenses. During evaporation, the refrigerant absorbs heating energy and during condensing, gives off heating energy.

Return pipe

The line in which the water is transported back to the indoor module from the house heating system (radiators/heating coils).

Return temp

The temperature of the water that returns to the indoor module after releasing the heat energy to the radiators/heating coils.

Room sensor

A sensor that is located indoors. This sensor tells the indoor module how hot it is indoors.

Safety valve

A valve that opens and releases a small amount of liquid if the pressure is too high.

Shunt

A valve that mixes the hot water with a small amount of slightly cooler water. There is a shunt in the indoor module that mixes the supply water with the return line so that the heating system reaches the correct temperature.

Shuttle valve

A valve that can send liquid in two directions. A shuttle valve that enables liquid to be sent to the climate system, when the heat pump produces heating for the house, and to the hot water side, when the heat pump produces hot water.

Supply temperature

The temperature of the heated water that the indoor module sends out to the heating system. The colder the outdoor temperature, the higher the supply line temperature becomes.

7 Item register

A

- Adjust the installation, 43
- Alarm, 56

B

- Back button, 13

C

- Contact information, 6
- Contact with VVM 310, 11
 - Display unit, 12
 - External information, 11
 - Menu system, 14
- Control knob, 13

D

- Display, 12
- Display unit, 12
 - Back button, 13
 - Control knob, 13
 - Display, 12
 - OK button, 13
 - Status lamp, 12
 - Switch, 13
- Disturbances in comfort, 56
 - Alarm, 56
 - Manage alarm, 56
 - Troubleshooting, 58

E

- External information, 11
 - Information window, 11
 - Status lamp, 11

G

- Get information, 40
- Glossary, 61

H

- Help menu, 20

I

- Important information, 2
 - Contact information, 6
 - Installation data, 2
 - Serial number, 5
 - VVM 310 – An excellent choice, 8
- Information window, 11
- Installation data, 2
- Installation function, 10

M

- Maintenance of VVM 310, 21
 - Regular checks, 21
 - Saving tips, 22
- Manage alarm, 56
- Menu system, 14
 - Help menu, 20
 - Operation, 16
 - Scroll through the windows, 20
 - Selecting menu, 16
 - Selecting options, 17
 - Setting a value, 18
 - Use the virtual keyboard, 19

O

- OK button, 13
- Operation, 16

P

- Power consumption , 22

R

- Regular checks, 21

S

- Saving tips, 22
 - Power consumption , 22
- Scroll through the windows, 20
- Selecting menu, 16
- Selecting options, 17
- Serial number, 5
- Set the hot water capacity, 36
- Set the indoor climate, 25
- Setting a value, 18
- Status lamp, 11–12
- Switch, 13

T

- Technical data, 60
- The heating installation – the heart of the house, 9
- Troubleshooting, 58

U

- Use the virtual keyboard, 19

V

- VVM 310 – An excellent choice, 8

VVM 310 – at your service, 25
Adjust the installation, 43
Get information, 40
Set the hot water capacity, 36
Set the indoor climate, 25

NIBE AB Sweden
Hannabadsvägen 5
Box 14
SE-285 21 Markaryd
info@nibe.se
www.nibe.eu

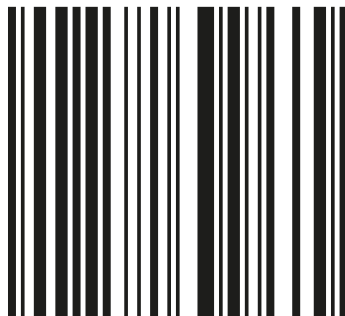

231176