

User manual  
**NIBE™ F2040**  
**8, 12, 16 kW**  
Air/water heat pump



# Table of Contents

<b>1</b>	<b><i>Important information</i></b>	<b>2</b>
	Installation data	2
	Safety information	3
	Serial number	4
	Contact information	7
	F2040 - An excellent choice	9
<b>2</b>	<b><i>The heat pump – the heart of the house</i></b>	<b>10</b>
	Heat pump function	10
	Contact with F2040	12
	Maintenance of F2040	13
<b>3</b>	<b><i>Disturbances in comfort</i></b>	<b>18</b>
	Troubleshooting	18
<b>4</b>	<b><i>Technical data</i></b>	<b>20</b>
<b>5</b>	<b><i>Glossary</i></b>	<b>21</b>
	<b><i>Item register</i></b>	<b>26</b>

# 1 Important information

## Installation data

Product	F2040
Serial number	
Installation date	
Installer	

### **Serial number must always be given**

Certification that the installation is carried out according to instructions in NIBE's installer manual and applicable regulations.

Date \_\_\_\_\_ Signed \_\_\_\_\_

## Safety information

This appliance can be used by children aged from 8 years and above and persons with reduced physical, sensory or mental capabilities or lack of experience and knowledge if they have been given supervision or instruction concerning use of the appliance in a safe way and understand the hazards involved. Children shall not play with the appliance. Cleaning and user maintenance shall not be made by children without supervision.

Rights to make any design or technical modifications are reserved.

©NIBE 2013.

### Symbols



#### NOTE

This symbol indicates danger to machine or person.



#### Caution

This symbol indicates important information about what you should observe when maintaining your installation.



#### TIP

This symbol indicates tips on how to facilitate using the product.

### Marking

The CE marking means that NIBE ensures that the product meets all regulations that are placed on it based on relevant EU directives. The CE mark is obligatory for most products sold in the EU, regardless where they are made.

## Serial number

The serial number for F2040 can be found on the side of the foot.

### F2040-8

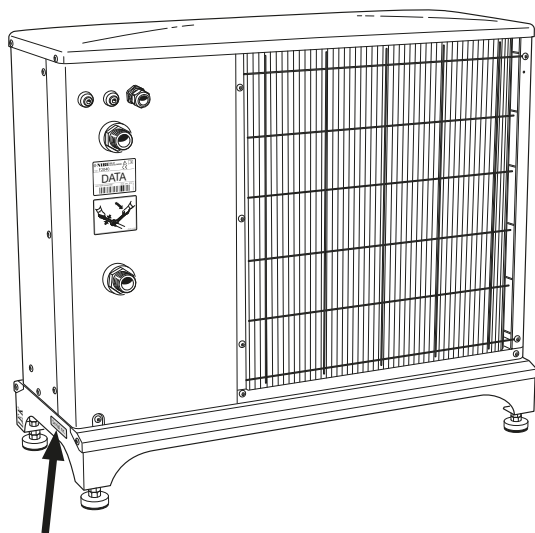

Serial number

# F2040-12

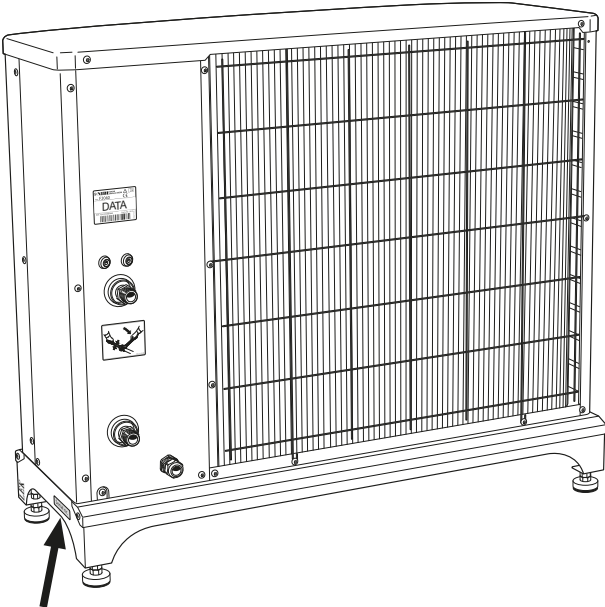

Serial number

## F2040-16

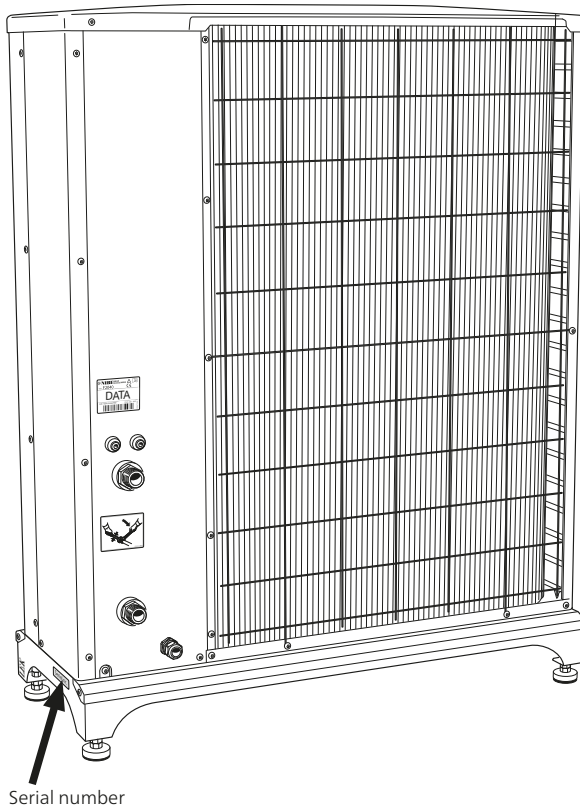

### Caution

Always give the product's serial number when reporting a fault.



## Contact information

**AT KNV Energietechnik GmbH**, Gahberggasse 11, 4861 Schörföling

Tel: +43 (0)7662 8963-0 Fax: +43 (0)7662 8963-44 E-mail: mail@knv.at  
www.knv.at

**CH NIBE Wärmetechnik AG**, Winterthurerstrasse 710, CH-8247 Flurlingen

Tel: (52) 647 00 30 Fax: (52) 647 00 31 E-mail: info@nibe.ch www.nibe.ch

**CZ Druzstevni zavody Drazice s.r.o.**, Drazice 69, CZ - 294 71 Benátky nad Jizerou

Tel: +420 326 373 801 Fax: +420 326 373 803 E-mail: nibe@nibe.cz  
www.nibe.cz

**DE NIBE Systemtechnik GmbH**, Am Reiherpfahl 3, 29223 Celle

Tel: 05141/7546-0 Fax: 05141/7546-99 E-mail: info@nibe.de  
www.nibe.de

**DK Vølund Varmeteknik A/S**, Member of the Nibe Group, Brogårdsvej 7, 6920 Videbæk

Tel: 97 17 20 33 Fax: 97 17 29 33 E-mail: info@volundvt.dk www.volundvt.dk

**FI NIBE Energy Systems OY**, Juurakkotie 3, 01510 Vantaa

Puh: 09-274 697 0 Fax: 09-274 697 40 E-mail: info@nibe.fi www.nibe.fi

**FR AIT France**, 10 rue des Moines, 67000 Haguenau

Tel : 03 88 06 24 10 Fax : 03 88 06 90 15 E-mail: info@nibe.fr www.nibe.fr

**GB NIBE Energy Systems Ltd**, 3C Broom Business Park, Bridge Way, Chesterfield S41 9QG

Tel: 0845 095 1200 Fax: 0845 095 1201 E-mail: info@nibe.co.uk  
www.nibe.co.uk

**NL NIBE Energietechniek B.V.**, Postbus 2, NL-4797 ZG WILLEMSTAD (NB)

Tel: 0168 477722 Fax: 0168 476998 E-mail: info@niben.nl www.niben.nl

**NO ABK AS**, Brobekkveien 80, 0582 Oslo, Postadresse: Postboks 64 Vollebakk, 0516 Oslo

Tel. sentralbord: +47 23 17 05 20 E-mail: post@abkklima.no www.nibeen-ergysystems.no

**PL NIBE-BIAWAR Sp. z o. o.** Aleja Jana Pawła II 57, 15-703 BIAŁYSTOK

Tel: 085 662 84 90 Fax: 085 662 84 14 E-mail: sekretariat@biawar.com.pl  
www.biawar.com.pl

**RU © "EVAN" 17**, per. Boynovskiy, Nizhny Novgorod

Tel./fax +7 831 419 57 06 E-mail: info@evan.ru www.nibe-evan.ru

**SE NIBE AB Sweden**, Box 14, Hannabadsvägen 5, SE-285 21 Markaryd

Tel: +46-(0)433-73 000 Fax: +46-(0)433-73 190 E-mail: [info@nibe.se](mailto:info@nibe.se)  
[www.nibe.se](http://www.nibe.se)

For countries not mention in this list, please contact Nibe Sweden or check [www.nibe.eu](http://www.nibe.eu) for more information.

## F2040 - An excellent choice

F2040 is an air/water heat pump specially developed for the Nordic climate, which utilises the outside air so there is no need for bore holes or coils in the ground.

The heat pump is intended for connection to water borne heating systems and can both heat hot water effectively at high outdoor temperatures and give a high output to the heating system at low outdoor temperatures.

If the outdoor temperature drops to a level below the stop temperature all heating must then occur with external additional heat.

### **Excellent properties for F2040:**

- ***Efficient twin rotary compressor***

Efficient twin rotary compressor that operates at temperatures down to -20 °C.

- ***Intelligent control***

F2040 connected to intelligent control for optimum control of the heat pump.

- ***Fan***

F2040 has automatic capacity regulation of the fan.

- ***Long service life***

The material has been chosen for a long service life and is designed to withstand the Nordic outdoor conditions.

The material has been chosen for a long service life.

- ***Many possibilities***

F2040 can with a NIBE hot water module, be used together with most electric boilers, oil boilers or similar.

- ***Silent operation***

F2040 has a silent operation function that allows scheduling when F2040 must operate at an even quieter noise level.

# 2 The heat pump – the heart of the house

## Heat pump function

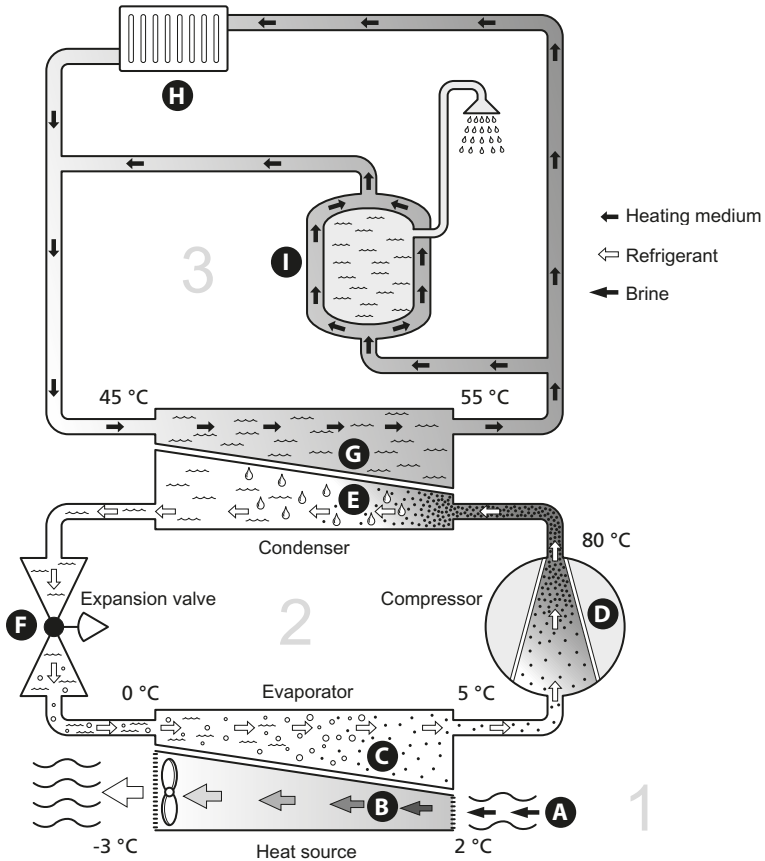

The temperatures are only examples and may vary between different installations and time of year.

An air/water heat pump can use the outdoor air to heat a property. The conversion of the outdoor air's energy to property heating occurs in three different circuits. In the brine circuit, (1), free heat energy is retrieved from the surroundings and transported to the heat pump. In the refrigerant circuit, (2), the heat pump increases the retrieved heat's low temperature to a high temperature. In the heating medium circuit, (3), the heat is distributed around the house.

### **Outdoor air**

- A** The outdoor air is sucked into the heat pump.
- B** The fan then routes the air to the heat pump's evaporator. Here, the air releases the heating energy to the refrigerant and the air's temperature drops. The cold air is then blown out of the heat pump.

### **Refrigerant circuit**

- C** A gas circulates in a closed system in the heat pump, a refrigerant, which also passes the evaporator. The refrigerant has a very low boiling point. In the evaporator the refrigerant receives the heat energy from the outdoor air and starts to boil.
- D** The gas that is produced during boiling is routed into an electrically powered compressor. When the gas is compressed, the pressure increases and the gas's temperature increases considerably, from 5 °C to approx. 80°C.
- E** From the compressor, gas is forced into a heat exchanger, condenser, where it releases heat energy to the heating system in the house, whereupon the gas is cooled and condenses to a liquid form again.
- F** As the pressure is still high, the refrigerant can pass an expansion valve, where the pressure drops so that the refrigerant returns to its original temperature. The refrigerant has now completed a full cycle. It is routed to the evaporator again and the process is repeated.

### **Heat medium circuit**

- G** The heat energy that the refrigerant produces in the condenser is retrieved by the climate system's water, heating medium, which is heated to 55 °C (supply temperature).
- H** The heating medium circulates in a closed system and transports the heated water's heating energy to the house water heater and radiators/heating coils.

The temperatures are only examples and may vary between different installations and time of year.

## Contact with F2040

F2040 has an integrated control system that controls and monitors the heat pump operation. At installation the installation engineer makes the necessary settings of the control system on the indoor module, so that the heat pump works optimally in your system.

The heat pump is controlled in different ways depending on your system. If you have an indoor module, e.g. VVM 310 or VVM 320, you can control heat pump operation from it. See relevant manual for more information.

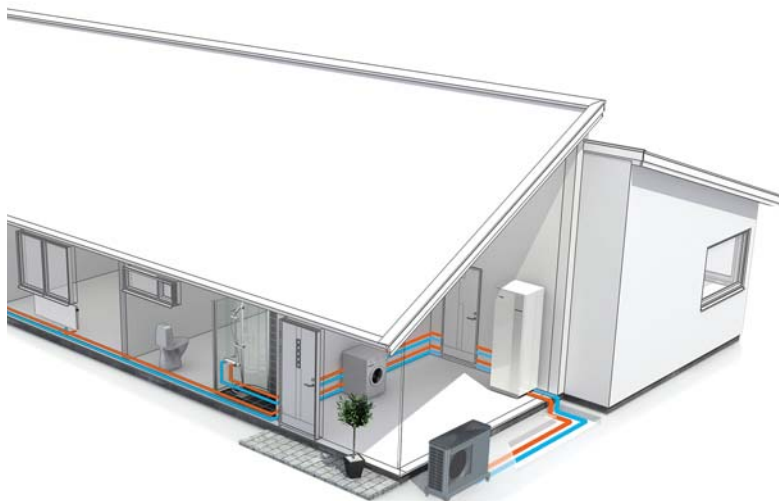

# Maintenance of F2040

## Regular checks

When your heat pump is located outdoors some external maintenance is required.



### NOTE

Insufficient oversight can cause serious damage to F2040 which is not covered by the guarantee.

### ***Checking grilles and bottom panel***

Check that the inlet grille is not clogged by leaves, snow or anything else regularly throughout the year.

You should be vigilant during windy conditions and/or in the event of snow as the grilles can become blocked.

Also check that the drain holes in the bottom panel (three) are free from dirt and leaves.

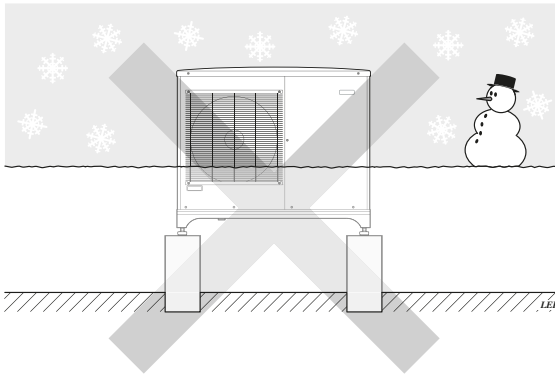

Prevent snow building up and covering the grille on F2040.

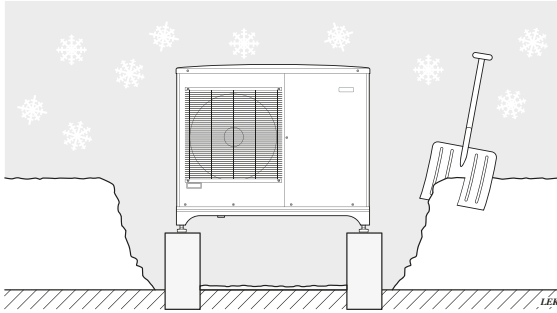

Keep free of snow and/or ice.

### ***Cleaning the outer casing***

If necessary the outer casing can be cleaned using a damp cloth.

Care must be exercised so that the heat pump is not scratched when cleaning. Avoid spraying water into the grilles or the sides so that water penetrates into F2040. Prevent F2040 coming into contact with alkaline cleaning agents.

### **In event of long power cuts**

In the event of prolonged power failures it is recommended that the part of the heating system located outdoors is drained. Your installer has installed a shut off and drain valve to facilitate this. Call and ask your installer if you are unsure.

### **Saving tips**

Your heat pump installation produces heat and cooling and/or hot water. This occurs via the control settings you made.

Factors that affect the energy consumption are, for example, indoor temperature, hot water consumption, the insulation level of the house and whether the house has many large window surfaces. The position of the house, e.g. wind exposure is also an affecting factor.

Also remember:

- Open the thermostat valves completely (except in the rooms that are to be kept cooler for various reasons, e.g. bedrooms). The thermostats slow the flow in the heating system, which the heat pump wants to compensate with increased temperatures. It then works harder and consumes more electrical energy.



- Reduce or adjust the settings for heating in any external control systems.

### **Power consumption**

The air/water heat pump's energy distribution spread across the year

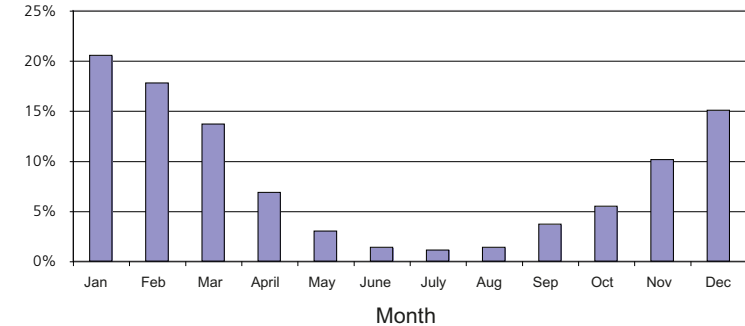

Increasing the indoor temperature one degree increases power consumption by approx. 5%.

### **Domestic electricity**

In the past it has been calculated that an average Swedish household has an approximate annual consumption of 5000 kWh domestic electricity/year. In today's society it is usually between 6000-12.000 kWh/year.

Equipment	Normal Output (W)		Approximate annual consumption (kWh)
	Operation	Standby	
Flat-screen (Operation: 5 h/day, Standby: 19 h/day)	200	2	380
Digital box (Operation: 5 h/day, Standby: 19 h/day)	11	10	90
DVD (Operation: 2 h/week)	15	5	45
TV games console (Operation: 6 h/week)	160	2	67
Radio/stereo (Operation: 3 h/day)	40	1	50

Equipment	Normal Output (W)		Approximate annual consumption (kWh)
Computer incl. screen (Operation: 3 h/day, standby 21 h/day)	100	2	120
Bulb (Operation 8 h/day)	60	-	175
Spot light, Halogen (Operation 8 h/day)	20	-	55
Cooler (Operation: 24 h/day)	100	-	165
Freezer (Operation: 24 h/day)	120	-	380
Oven, hob (Operation: 40 min/day)	1500	-	365
Oven (Operation: 2 h/week)	3000	-	310
Dishwasher, cold water connection (Operation 1 time/day)	2000	-	730
Washing machine (Operation: 1 time/day)	2000	-	730
Tumble drier (Operation: 1 time/day)	2000	-	730
Vacuum cleaner (Operation: 2 h/week)	1000	-	100
Engine block heater (Operation: 1 h/day, 4 months a year)	400	-	50
Passenger compartment heater (Operation: 1 h/day, 4 months a year)	800	-	100

These values are approximate example values.

Example: A family with 2 children live in a house with 1 flat-screen TV, 1 digital box, 1 DVD player, 1 TV games console, 2 computers, 3 stereos, 2 bulbs in the WC, 2 bulbs in the bathroom, 4 bulbs in the kitchen, 3 bulbs outside, a washing machine, tumble drier, fridge, freezer, oven, vacuum cleaner, engine block heater = 6240 kWh domestic electricity/year.

### **Energy meter**

Check the accommodation's energy meter regularly, preferably once a month. This will indicate any changes in power consumption.

Newly built houses usually have twin energy meters, use the difference to calculate your domestic electricity.

### ***New builds***

Newly built houses undergo a drying out process for a year. The house can then consume significantly more energy than it would thereafter. After 1-2 years the heating curve should be adjusted again, as well as the heating curve offset and the building's thermostat valves, because the heating system, as a rule, requires a lower temperature once the drying process is complete.

# 3 Disturbances in comfort

## Troubleshooting



### NOTE

Work behind covers secured by screws may only be carried out by, or under the supervision of, a qualified installation engineer.



### NOTE

As F2040 can be connected to a large number of external units, these should also be checked.



### NOTE

If the operating disturbance cannot be rectified by means of this chapter, an installation engineer should be called.



### NOTE

In the event of action to rectify malfunctions that require work within screwed hatches the incoming electricity must be isolated at the safety switch.

The following tips can be used to rectify comfort disruption:

### Basic actions

Start by checking the following possible fault sources:

- That the heat pump is running or that the supply cable to F2040 is connected.
- Group and main fuses of the accommodation.
- The property's earth circuit breaker.

### Low hot water temperature or a lack of hot water

This part of the fault-tracing chapter only applies if the heat pump is docked to the hot water heater.

- Large hot water consumption.
  - Wait until the hot water has heated up.

- Incorrect settings in the NIBE indoor module.
  - See the manual for the indoor module.

### **Low room temperature**

- Closed thermostats in several rooms.
  - Set the thermostats to max in as many rooms as possible.
- External switch for changing the room heating activated.
  - Check any external switches.
- Incorrect settings in NIBE SMO or NIBE indoor module
  - See the manual for the indoor module.

### **High room temperature**

- External switch for changing the room heating activated.
  - Check any external switches.
- Incorrect settings in NIBE SMO or NIBE indoor module
  - See the manual for the indoor module.

### **F2040 is not operational**

F2040 communicates all alarms to the indoor module.

- Ensure that the F2040 is connected to the power source.
- Check the indoor module. See section "Disturbances in comfort" in the installation manual for the indoor module.

### **F2040 does not communicate**

- Check that the addressing of F2040 is correct.
- Check that the communication cable has been connected.

# 4 Technical data

Detailed technical specifications for this product can be found in the installation manual ([www.nibe.eu](http://www.nibe.eu)).

# 5 Glossary

## **Additional heat:**

The additional heat is the heat produced in addition to the heat supplied by the compressor in your heat pump. Additional heaters can be for example, immersion heater, electric heater, solar power system, gas/oil/pellet/wood burner or district heating.

## **Ambient temperature sensor**

A sensor that is located outdoors on or close to the heat pump. This sensor tells the heat pump how hot it is where the sensor is located.

## **Balance temperature**

The balance temperature is the outdoor temperature when the heat pump's stated output is equal to the building's output requirement. This means that the heat pump covers the whole building's output requirement down to this temperature.

## **Charge coil**

A charge coil heats the domestic hot water (tap water) in the heater with heating water from F2040.

## **Charge pump**

See "Circulation pump".

## **Circulation pump**

Pump that circulates liquid in a pipe system.

## **Climate system**

Climate systems can also be called heating systems. The building is heated using radiators, under floor coils or convector fans.

## **Coil tank**

A heater with a coil in it. The water in the coil heats the water in the heater.

## **Compressor**

Compresses the gas state refrigerant. When the refrigerant is compressed, the pressure and the temperature increase.

## **Condenser**

Heat exchanger where the hot gas state refrigerant condenses (cooled and becomes a liquid) and releases heat energy to the house heating and hot water systems.

## **COP**

If it is stated that a heat pump has COP 4, this means, in principle that if you insert 10 pence, you will get 40 pence worth of heat. It is the efficiency of the heat pump. This is measured at different measurement values, e.g.: 7/45 where 7 stands for the outdoor temperature and 45 for how many degrees the supply temperature is.

## **Defrosting**

A short process that periodically thaws ice on the evaporator using heat from the heating medium. Large quantities of condensation water can occur and must be routed away.

## **Disturbances in comfort**

Disturbances in comfort are undesirable changes to the hot water/indoor comfort, for example when the temperature of the hot water is too low or if the indoor temperature is not at the desired level.

A malfunction in the heat pump can sometimes be noticed in the form of a disturbance in comfort.

In most cases, the heat pump notes malfunctions and indicates this with alarms in the display.

## **Domestic hot water**

The water one showers in for example.

## **Double-jacketed tank**

A heater with domestic hot water (tap water) is surrounded by an outer vessel with boiler water (to the house radiators/elements). The heat pump heats the boiler water, which in addition to going out to the all the house radiators/elements, heats the domestic hot water in the inner vessel.



## **Efficiency**

A measurement of how effective the heat pump is. The higher the value is the better it is.

## **Electrical addition**

This is electricity that, for example, an immersion heater uses as addition during the coldest days of the year to cover the heating demand that the heat pump cannot manage.

## **Evaporator**

Heat exchanger where the refrigerant evaporates by retrieving heat energy from the air which then cools.

## **Expansion valve**

Valve that reduces the pressure of the refrigerant, whereupon the temperature of the refrigerant drops.

## **Expansion vessel**

Vessel with heating medium fluid with the task of equalising the pressure in the heating medium system.

## **Flow pipe**

The line in which the heated water is transported from the heat pump out to the house heating system (radiators/heating coils).

## **Heat exchanger**

Device that transfers heat energy from one medium to another without mixing mediums. Examples of different heat exchangers are evaporators and condensers.

## **Heat factor**

Measurement of how much heat energy the heat pump gives off in relation to the electric energy it needs to operate. Another term for this is COP.

## **Heating medium**

Hot liquid, usually normal water, which is sent from the heat pump to the house climate system and makes the accommodation warm. The heating medium also heats the hot water.

## **Heating medium side**

Pipes to the house's climate system make up the heating medium side.

## **Hot water heater**

Container where domestic water is heated. Is located somewhere outside the heat pump.

## **Pressostat**

Pressure switch that triggers an alarm and/or stops the compressor if non-permitted pressures occur in the system. A high pressure pressostat trips if the condensing pressure is too great. A low pressure pressostat trips if the evaporation pressure is too low.

## **Radiator**

Another word for heating element. They must be filled with water in order to be used with F2040.

## **Refrigerant**

Substance that circulates around a closed circuit in the heat pump and that, through pressure changes, evaporates and condenses. During evaporation, the refrigerant absorbs heating energy and during condensing, gives off heating energy.

## **Return pipe**

The line in which the water is transported back to the heat pump from the house heating system (radiators/heating coils).

## **Return temp**

The temperature of the water that returns to the heat pump after releasing the heat energy to the radiators/heating coils.

## **Safety valve**

A valve that opens and releases a small amount of liquid if the pressure is too high.

## **Shuttle valve**

A valve that can send liquid in two directions. A shuttle valve that enables liquid to be sent to the climate system, when the heat pump produces heating for the house, and to the hot water heater, when the heat pump produces hot water.

## **Supply temperature**

The temperature of the heated water sent by the heat pump to the heating system.

# 6 Item register

## C

- Contact information, 7
- Contact with F2040, 12
- Control module's function, 10

## D

- Disturbances in comfort
  - Troubleshooting, 18

## F

- F2040 – An excellent choice, 9

## G

- Glossary, 21

## H

- Heat pump function, 11

## I

- Important information, 2
  - Contact information, 7
  - F2040 – An excellent choice, 9
  - Installation data, 2
  - Serial number, 4
- In event of long power cuts, 14
- Installation data, 2

## M

- Maintenance of F2040, 13
  - In event of long power cuts, 14
  - Regular checks, 13
  - Saving tips, 14

## P

- Power consumption , 15

## R

- Regular checks, 13

## S

- Saving tips, 14
  - Power consumption , 15
- Serial number, 4

## T

- Technical data, 20
- The heat pump – the heart of the house, 10
- Troubleshooting, 18







NIBE AB Sweden  
Hannabadsvägen 5  
Box 14  
SE-285 21 Markaryd  
info@nibe.se  
www.nibe.eu

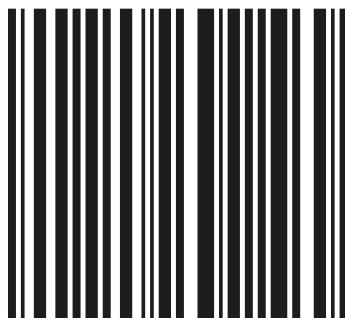

231845